



HCFC Detector

■ X P-7 0 4 III

Gas Leak Detector Instruction Manual

- Keep this instruction manual available for quick reference when needed.
- Read this instruction manual and thoroughly understand before using the product.



NEW COSMOS ELECTRIC CO., LTD.

Table of Contents

| | |
|--------------------------------------------------------|----|
| Included in this Package | 1 |
| 1. Introduction | 2 |
| Symbols | 2 |
| Safe Operation | 3 |
| 2. Part Names and Functions | 4 |
| 3. Operating Procedure | 7 |
| Drain Filter | 7 |
| Operating Procedure | 8 |
| Silent Mode | 11 |
| Deactivating the Alarm Buzzer | 12 |
| Lighting the Backlight | 12 |
| 4. Error Displays | 13 |
| 5. Replacement of Consumable Parts | 14 |
| Filter Element Replacement | 14 |
| Dust Filter Replacement | 15 |
| Battery Replacement | 16 |
| 6. Maintenance Check | 17 |
| Daily Check | 17 |
| Periodic Inspection | 17 |
| Consumable Parts, Replacement Parts, and Options | 18 |
| 7. Troubleshooting | 19 |
| 8. Warranty | 20 |
| 9. Specifications | 21 |
| 10. Detection Principle | 22 |

— Included in this Package —

The package includes the items listed in the following table. Before using the Gas Leak Detector, be sure to check that all items have been provided. Every precaution has been taken in preparing the Gas Leak Detector. However, if any items are missing or damaged, please contact your New Cosmos distributor. Replacements for any missing or damaged items will be sent.

| Name | Quantity |
|------------------------------------|----------|
| Gas Leak Detector (with soft case) | 1 |
| DF-114 Drain Filter | 1 |
| Replacement FE-2 Filter Element | 1 |
| AT-2G Gas Probe | 1 |
| FE-106 Dust filter | 1 |
| EG-10 Test Gas | 1 |
| Hand Strap | 1 |
| Size AA Alkaline Batteries | 2 |
| Instruction Manual | 1 |
| Operation Guide | 1 |
| Inspection Report | 1 |

● Options (Sold Separately)^{*1}

| Name | Model |
|--------------------|-------|
| Gas Collector | AT-6 |
| Gas Collector | AT-7A |
| Telescopic Probe | RP-4 |
| Gas Collection Set | ATS-6 |

^{*1} Refer to page 18 for details of options.

1. Introduction

Thank you for purchasing a New Cosmos Gas Leak Detector. Please read this Instruction Manual thoroughly before using the Gas Leak Detector to help prevent gas leakage accidents and to aid in safety inspections.



XP-704III Gas Leak Detector detects leakage of Hydrochlorofluorocarbon. When the gas concentration exceeds the set value, a buzzer and lamp provide notification of the gas leakage to help prevent gas leak accidents.

Read and understand thoroughly this Instruction Manual regardless of your experience with using Gas Leak Detectors.

Do not use this Gas Leak Detector for improper purpose. Do not use this Gas Leak Detector in undocumented way in this manual.

Symbols

The following symbols are used for safety purposes:

| | |
|--------------------------------------------------------------------------------------------------|------------------------------------------------------------------------------------------------------------------|
|  DANGER | Indicates an imminently hazardous situation, which will result in death or serious injury if not avoided. |
|  WARNING | Indicates a potentially hazardous situation, which will result in death or serious injury if not avoided. |
|  CAUTION | Indicates a potentially hazardous situation, which may result in minor injury or property damage if not avoided. |
| NOTE | Operational advice and/or instruction. |

Safe Operation

Be sure to observe the following to use the product safely and properly.



DANGER

During the gas detection, there is a possibility of the target gas being emitted from the outlet of Gas Leak Detector.

- Do not breathe in gas.
- Do not bring fire close to the Gas Leak Detector.



WARNING

- Be sure to turn ON the power in clean air. Since zero adjustment is performed automatically, the proper gas concentration will not be displayed when turning on the power in gas atmosphere.
- Do not block the inlet and outlet. Otherwise, it may not be able to detect properly
- Do not allow water or liquids to enter the Gas Leak Detector. It may cause interference to the gas detection and may damage the Gas Leak Detector.
- Make sure that Filter Element is clean. If the Filter Element is dirty or wet, it may not be able to detect properly.
- Do not block the buzzer hole. It will muffle the alarm.
- Since XP-704III does not have an explosion-proof construction, do not use in hazardous area.





CAUTION

- Remove the batteries if the Gas Leak Detector will not be used for an extended period of time.
- Check the remaining battery charge periodically (approximately once a month) even if the Gas Leak Detector remains unused for an extended period of time. Replace batteries if the batteries are leaking when the remaining battery charge is low.
- To avoid damaging its performance, never attempt to disassemble, alter, or change the structure or electric circuits of the Gas Leak Detector.
- Do not leave the Gas Leak Detector in hot and humid environment for a long period of time. It may affect its performance.
- Do not use the Gas Leak Detector in places where the temperature or humidity fluctuates greatly. It may affect its performance.
- Keep the Gas Leak Detector away from significant changes in atmospheric pressure. It may affect the performance of or damage the sensor.
- Avoid high mechanical impacts, dropping and throwing the Gas Leak Detector. It may affect its performance.
- In case of dew condensation, conduct an inspection after drying the Gas Leak Detector completely before use.
- Do not use the Gas Leak Detector near silicon sealing agents or in atmosphere containing silicon gas. It may affect its performance.
- The Gas Leak Detector may detect gas or solvent vapors other than the target gas. Consider the inspection environment when using the Gas Leak Detector.
- Detecting high concentration of SO₂ or Cl₂ may decrease the sensor life or increase errors.
- It has a simple drip-proof structure by using a soft case. Avoid exposure to water as much as possible
- Keep away from the wireless applications. It may start sounding alarm near the wireless applications while in use.

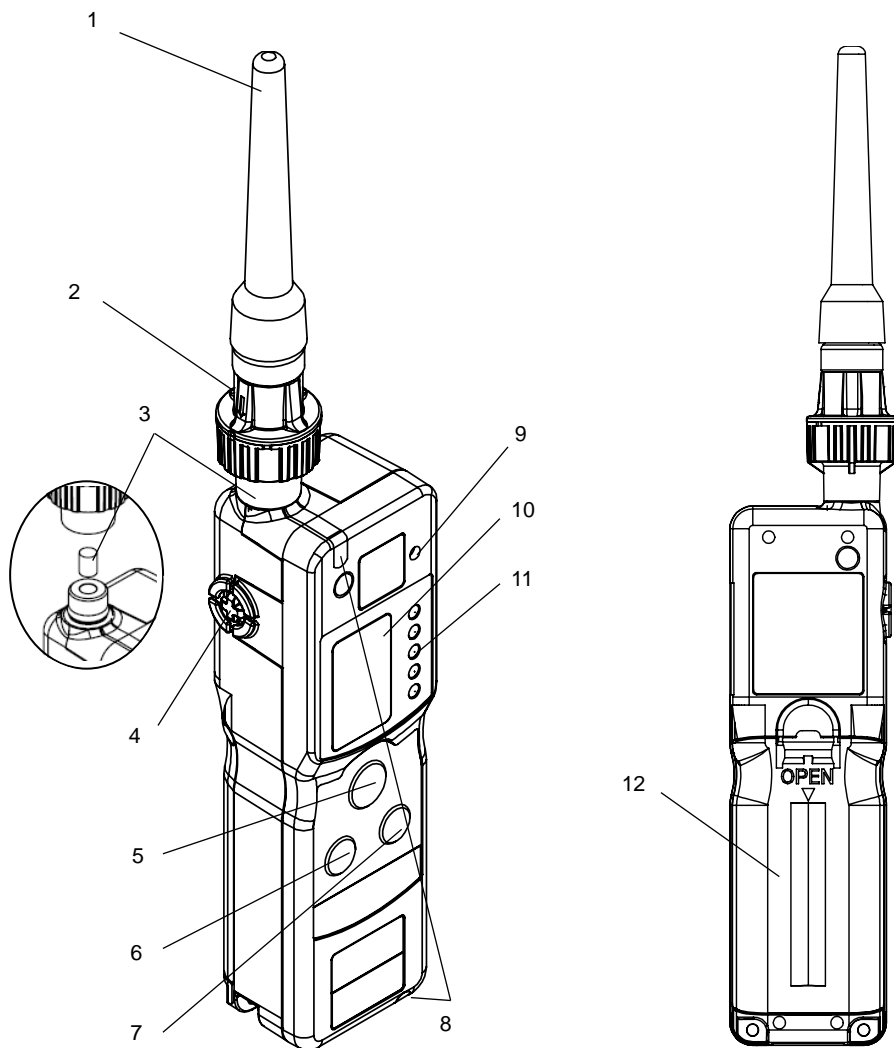
2. Part Names and Functions

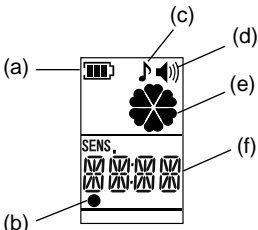

| No. | Name | Functions |
|-----|-------------------------------------------------------------------------------------------|-------------------------------------------------------------------------------------------------------------------------------------------------------------------------------------------------------------------------------------------------------------------------------------------------------------------------------------------------------------------------------------------------------------------------------------------------------------------------------------------------------------------------------------------------------------------------------------------------------------------------------------------------------------------------------------------------------------------|
| 1 | AT-2G Gas Probe | Gas inlet. |
| 2 | DF-114 Drain Filter | Protects the Gas Leak Detector from water, dust, and other foreign matter. |
| 3 | FE-106 Dust Filter | Protects the Gas Leak Detector from fine dust, sand, and other foreign matter. |
| 4 | Outlet | Gas outlet to exhaust sampled gas. |
| 5 | POWER/ SENSITIVITY Button | Turns the power ON and OFF. Sets the detection sensitivity level. |
| 6 | BUZZER Button | Turns the alarm buzzer and operation sound ON and OFF. Switches the gas types for two-gas model. |
| 7 | ZERO/ RESTART PUMP/ BACKLIGHT Button | Restarts pump operation after a pump error. Also lights the LCD backlight and displays the target gas name on the LCD. |
| 8 | Alarm/ Error Lamps (red) | Light up or flash when detecting gas leakage. The flashing frequency increases as the concentration of the gas leak increases. The lamps light if the concentration is very high. These lamps also flash when an error occurs in the pump or sensor. |
| 9 | Buzzer hole | The buzzer sounds. |
| 10 | LCD  | <p>Displays the gas sensitivity and messages.</p> <p>(a) The remaining battery charge is displayed. Battery charge: High Low </p> <p>(b) It indicates a possible status of zero adjustment.</p> <p>(c) It shows the operation sound. (The indicator is displayed only when the operation sound is turned ON.)</p> <p>(d) It shows the alarm sound. (The icon is displayed only when the alarm sound is ON.)</p> <p>(e) The pump operation is displayed. (The indicator rotates if the pump is operating normally.)</p> <p>(f) The detection sensitivity level, target gas name, and errors are displayed.</p> |
| 11 | Gas Sensitivity Lamps (green) | Indicate the detection sensitivity level. There are five detection sensitivity levels. |
| 12 | Battery Lid | The cover to the battery compartment. |

Soft case



| No. | Name | Functions |
|-----|---------------|----------------------------------------------|
| 1 | Side Zipper | Open the zipper to replace the batteries. |
| 2 | Back Pocket | The Operating Guide is stored here. |
| 3 | Inside Pocket | A Replacement Filter Element is stored here. |

3. Operating Procedure

■ Drain Filter

Connect DF-114 Drain Filter and AT-2 Gas Probe to the Gas Leak Detector before use.

1. Store the Gas Leak Detector into the soft case, zip the soft case up (both sides) and close the Velcro.
(The Gas Leak Detector is in the soft case at the time of shipment from the factory)
2. Insert AT-2 Gas Probe to DF-114 Drain Filter.
(AT-2 Gas Probe is inserted to DF-114 at the time of shipment from the factory)
3. Twist DF-114 Drain Filter clockwise to the Gas Leak Detector and fasten up.
(If the Drain Filter is not connected, it cannot detect properly)

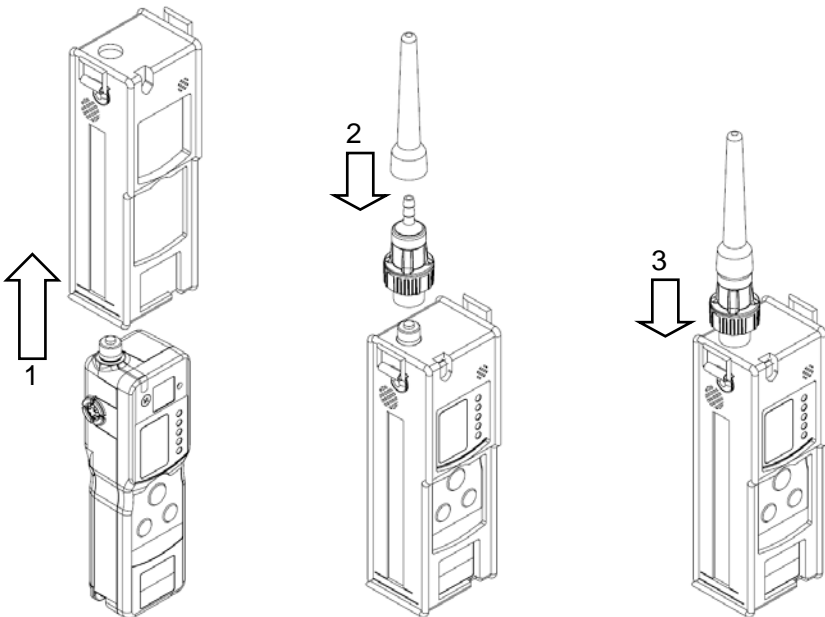

Operating Procedure

WARNING Always perform a daily check before using the Gas Leak Detector. (Refer to page 17.)



1. Insert the batteries

There are no batteries in the Gas Leak Detector at the point of purchase. Insert the enclosed batteries. (Refer to *Battery Replacement* on page 16.)

2. Turn ON the power, Warm up, Displays gas sensitivity

WARNING Be sure to turn ON the power in clean air. Since zero adjustment is performed automatically, it cannot detect properly when turning on the power in gas atmosphere.

- 1) Press the “POWER/ SENSITIVITY” Button for approximately one second. The buzzer beeps and the power will be ON.
- 2) “ADJ” is displayed and blinking on the LCD while the Gas Leak Detector is warming up. The stability of sensor is indicated with five gas sensitivity lamps (green). As the sensor stabilizes, the flashing lamp moves down in order from the lowest sensitivity level (3). Before warm-up is completed, the highest sensitivity level (0) lamp will flash. (The maximum warm-up is three minutes.)

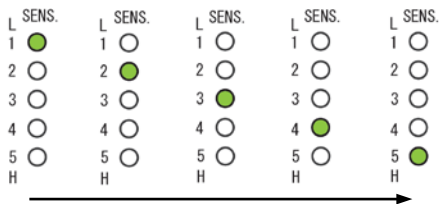

NOTE If the sensor stabilizes quickly, all of the lamps may not flash one at a time. If the Gas Leak Detector remains unused for an extended period of time, the warm-up time may increase and “E-S” may be displayed on the LCD. (Refer to *Sensor Error* on page 13.) If sensor error is displayed, cycle the power.

3) When the warm-up operation is completed, the buzzer sounds once, a gas sensitivity lamp (green) lights, and the detection sensitivity level is displayed on the LCD. The default detection sensitivity level is [3] when the batteries are inserted. It will start up next time with the same detection sensitivity level.

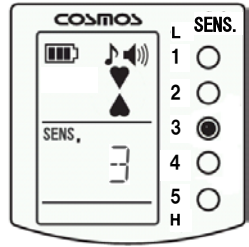

4) The detection sensitivity can be set from five levels in descending order of sensitivity 5, 4, 3, 2 and 1. Change the detection sensitivity as needed.

| | |
|-------------|-----------------------------------------------------------------------------------------------------------------------------------------------------------------------------------------------------------------------------------------------------------------------------------------------------------------------------------------------------------------------|
| NOTE | <ul style="list-style-type: none"> The detected gas concentrations for the detection sensitivity levels are as follows. <ul style="list-style-type: none"> Level 5: Detects concentration of 5 ppm or less. (30ppm or less for R-134a) Level 4: Detects concentrations of around 30 ppm. (Around 100ppm for R-134a) |
|-------------|-----------------------------------------------------------------------------------------------------------------------------------------------------------------------------------------------------------------------------------------------------------------------------------------------------------------------------------------------------------------------|

● To Decrease the Detection sensitivity level
 Each time pressing the "POWER/ SENSITIVITY" button, the buzzer will sound once and the detection sensitivity level will decrease one level. The lighted gas sensitivity lamp (green) will move up one by one, and the LCD will also display the same sensitivity level as shown on the gas sensitivity lamp.
 When the detection sensitivity level is decreased beyond 1, the level will return to level 5.

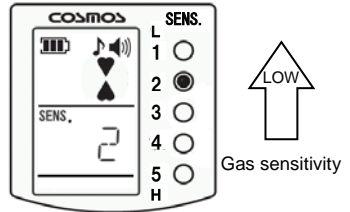

| | |
|-------------|-------------------------------------------------------------------------------------|
| NOTE | Press the "POWER/SENSITIVITY" button for more than 3 seconds to turn OFF the power. |
|-------------|-------------------------------------------------------------------------------------|

● To Increase the Detection sensitivity level
 Each time pressing the "POWER/ SENSITIVITY" button twice (like double-click), the buzzer will sound twice and the detection sensitivity level will increase one level. The lighted gas sensitivity lamp (green) will move down one by one, and the LCD will also display the same sensitivity level as shown on the gas sensitivity lamp.
 When the detection sensitivity level is increased beyond 5, the level will return to level 1.

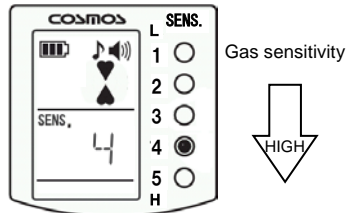

3. Zero Adjustment



CAUTION

- Perform zero adjustment in clean air just before detection to set the detection sensitivity level 5 or 4. Since the sensitivity is high, it is susceptible to surrounding environment to perform proper detection.
- It can be used even a small dot “status of zero adjustment” is blinking or not displayed, but cannot obtain an accurate detection.

Before detection, check a small dot “status of zero adjustment” on the bottom-left corner of LCD, and follow the instructions below according to its status.

Displayed: Zero adjustment is not necessary to set the detection sensitivity level 3, 2, or 1. Perform zero adjustment to set the detection sensitivity level 4 or 5.

Blinking: Perform zero adjustment.

When it alternates between on and off, it appears to be blinking. In this case, cycle the power by turning OFF and then ON.

OFF: Zero adjustment is not available (There is a possibility of presence of gas). Wait for a while until it starts blinking. If it does not start blinking after a few minutes, cycle the power by turning OFF and then ON.

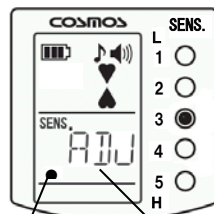

Status of zero adjustment

“ADJ” is displayed

Press and hold the “ZERO/ RESTART PUMP/ BACKLIGHT” button for 3 seconds to start zero adjustment.

- When zero adjustment is available, “ADJ” is displayed on the LCD for 3 seconds with a beep sound, and then returns to the detection sensitivity level indication.
- When zero adjustment is not available, the buzzer will sound and the detection sensitivity level remains displaying on the LCD.

4. Detection



DANGER

- Alarm Buzzer
If the alarm buzzer sounds or the alarm lamp (red) lights up/ flashes, take necessary measures.
- If the remaining battery charge indicator  appears, replace the batteries in a non-hazardous clean air location promptly. (Refer to *Battery Replacement* on page 16.)
If “E-B” is displayed on the LCD (refer to *Battery Alarm* on page 13), the buzzer will start sounding continuously and the Gas Leak Detector will not be working. Early battery replacement is recommended.

Move the Gas Probe towards the detection place. When the Gas Leak Detector detects a gas leak, the alarm lamp (red) will flash and the alarm buzzer will start sounding continuously. As the gas concentration increases, the alarm buzzer will sound more frequently and will change to continuous sound. (The alarm buzzer will sound faster as approaching the location of gas leak.)

The alarm lamp (red) will flash and then light continuously in sync with the alarm buzzer.

NOTE

The alarm buzzer can be turned ON and OFF as needed. (Refer to *Deactivating the Alarm Buzzer* on page 12.)

5. Turn OFF the power



- **CAUTION** Make sure that the alarm buzzer is not sounding before turning OFF the power. If the alarm buzzer is sounding when turning OFF the power, a sensor error (refer to page 13) may occur at the next use.
- In case of detecting high concentration gas, take in clean air for several minutes before turning OFF the power to prevent affecting the performance.

After the detection, press the “POWER/ SENSITIVITY” button for 3 seconds. The buzzer sounds three times and the power will go OFF.

- **Automatic Gas Exhaust Mode**

If there is any gas remaining in the Gas Leak Detector when the power is turned OFF, it will enter automatic gas exhaust mode. When it enters automatic gas exhaust mode, the buzzer will sound once, “60” will be displayed on the LCD, and a countdown will start (59, 58...).

Silent Mode (No Operation Sound)



CAUTION

In silent mode, the Gas Leak Detector produces no sounds at all except for errors and the battery alarm. It will be impossible to confirm operation audibly. Avoid using silent mode unless it is absolutely necessary, and make sure to cancel silent mode after use.

Operation sound indicator Alarm sound icon

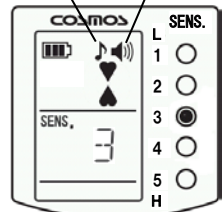

Press the “BUZZER” button for 3 seconds while the power is ON to enter silent mode.

In silent mode, the operation sound and alarm buzzer will not function and the operation sound and alarm sound icon on the LCD will not be displayed. However, the error alarm buzzer and battery alarm buzzer (in unusable state) will sound. (Refer to *Error Displays* on page 13 and to *Battery Replacement* on page 16.)

To cancel silent mode, press the “BUZZER” button again for 3 seconds. The alarm buzzer cannot be turned ON or OFF unless silent mode is cancelled. (Refer to *Deactivating the Alarm Buzzer* on page 12.)

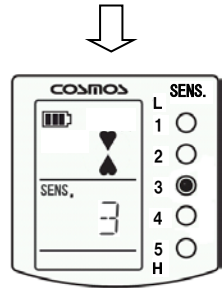

NOTE

Silent mode will remain in effect even when the power is turned OFF unless silent mode is cancelled or unless the batteries are replaced.

Deactivating the Alarm Buzzer

The alarm buzzer for gas detection can be turned ON or OFF.

Press the buzzer button while the power is ON, the buzzer sounds once and the alarm buzzer sound will be turned ON or OFF.

The alarm sound icon on the LCD will light (buzzer ON) or go out (buzzer OFF).

Alarm sound icon

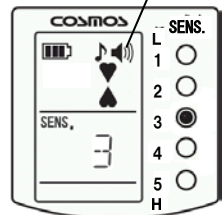

NOTE

- When the power is turned ON again, the alarm buzzer sound setting will be the same as before the power was turned OFF. However, the alarm buzzer sound will be turned ON after the battery replacement.
- The alarm buzzer sound cannot be turned ON or OFF while in silent mode.

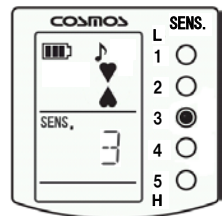

Lighting the Backlight





Tap the “ZERO/ RESTART PUMP/ BACKLIGHT” button to light up the backlight for 30 seconds. The backlight will also light up automatically for approximately 15 seconds when an error occurs.

NOTE

To extend the battery life, the backlight will not light up when the remaining battery charge level indicator is the lowest level (Battery outline only).

4. Error Displays

If an error occurs with the Gas Leak Detector, the error lamps will flash, an error will be displayed on the LCD, and the buzzer will sound repeatedly. The major errors are described in the following table. Take the corresponding action given in the table.

| Error | Error Display | Cause | Solution |
|----------------|------------------------------------------------------------------------------------------------------------|--------------------------------------------------------------------|-----------------------------------------------------------------------------------------------------------------------------------------------------------------------------------------------------------------------------------------------------------------------------------------|
| Sensor Error | (Error lamps flash)  | There may have been gas present when the power was turned ON. | Turn ON the power again in clean air. If the same error occurs even after turning ON the power several times, there may be a problem with the sensor. Request repairs. |
| Pump Error | (Error lamps flash)  | Water or liquid may have been sampled or the inlet may be blocked. | Remove the water or liquid. (Refer to <i>Filter Element Replacement</i> on page 14.) If the same error occurs even after pressing the "ZERO/RESTART PUMP/ BACK-LIGHT" button, the pump may have failed, or water or liquid may have been in the Gas Leak Detector. Request for repairs. |
| Battery Alarm | (Error lamps flash)  | The battery voltage is too low to operate. | Replace batteries. (Refer to <i>Battery Replacement</i> on page 16.) |
| Detector Error | (Error lamps flash)  | A problem may have occurred in the Gas Leak Detector. | Request for repairs. |

5. Replacement of Consumable Parts

Filter Element Replacement

When the Filter Element is dirty or wet, or when the water or liquid is inside the Drain Filter, clean out the Drain Filter and replace the Filter Element.

- CAUTION**
- Do not replace the Filter Element while the Gas Leak Detector is operating. Dust or other foreign matter may enter the Gas Leak Detector.
 - Mount the Filter Element correctly. If the Filter is not in place properly, it will not function properly and will not be able to detect correctly.
 - Attach the filter case securely. If the filter case is loose, water or other foreign matter may leak into the Gas Leak Detector.
 - If water or liquid reaches inside the Gas Leak Detector through the Filter Element, it is in need of repair. It will not be able to detect correctly.

NOTE Do not push or poke the Filter Element. It may damage the waterproof structure.

- 1) Turn the filter case counterclockwise and remove it.

CAUTION If water, dust, or other foreign matter is in the Drain Filter, be careful not to enter into the Gas Leak Detector.

- 2) Remove the O-ring from inside the cap.
- 3) Replace the Filter Element with a new filter.

NOTE Clean the inside of the cap and filter case with a dry cloth as needed. Remove water or liquid completely and dry the parts before replacing with a new Filter Element.

CAUTION Make sure to attach FE-2 Filter Element between the cap and the filter case.

- 4) Attach the O-ring, put the filter case back together and reassemble.

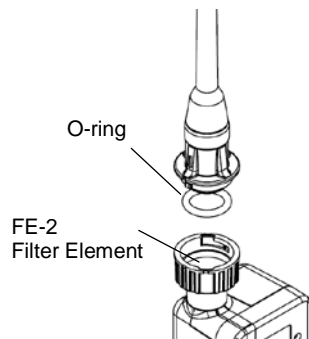
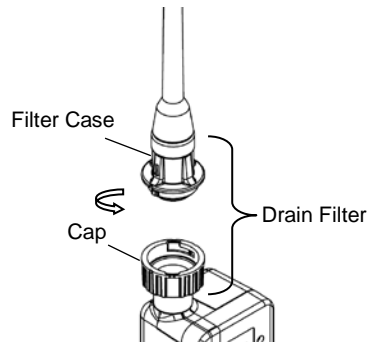

Dust Filter Replacement



CAUTION

- Make sure to attach FE-2 Filter Element in the Drain Filter when using FE-106 Dust Filter.
- It cannot prevent water from entering into the Gas Leak Detector unless using FE-2 Filter Element.
- Do not replace FE-106 Dust Filter while the Gas Leak Detector is operating.

FE-106 Dust Filter prevents to enter dust particles and sand into the pump inside the Gas Leak Detector. Do not remove the Dust Filter.

The Dust Filter will be kept clean in normal use (with DF-114 Drain Filter). However, the Dust Filter is available for replacement as needed (sold separately).

- 1) Turn the cap of the Drain Filter counterclockwise to remove together with the Gas Probe.

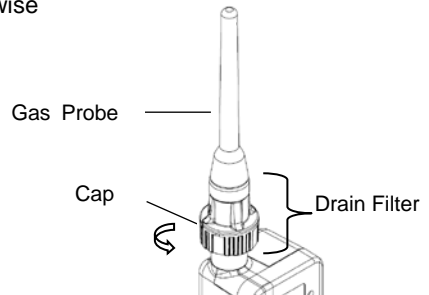

- 2) Remove FE-106 Dust Filter and replace with a new filter.

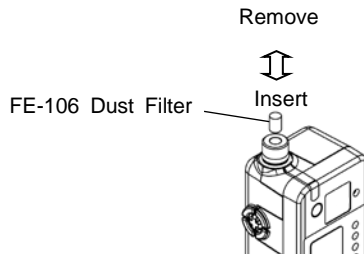

- 3) Attach the Drain Filter and reassemble.

Battery Replacement

WARNING • Be sure to use two AA alkaline dry cell batteries (LR6).

When the remaining battery charge indicator changes to  , the battery charge is low.

When the battery voltage drops and reaches to the final voltage, “E-B” (refer to *Battery Alarm* on page 13) will be displayed on the LCD and the Gas Leak Detector will not be working. Replace the batteries.

NOTE

- Use the same kind of unused batteries.
- Always replace two batteries at the same time.
- Due to the characteristics of the batteries, the battery life will be shorter in low-temperature environment.

- 1) Open the Velcro tape of the soft case and open the side zipper.
- 2) Open the battery lid of the back of the Gas Leak Detector and install two new batteries (size AA alkaline) as shown on the bottom of the compartment.
- 3) Close the battery lid firmly.
- 4) Zip the right and left of the soft case and close the Velcro tape.

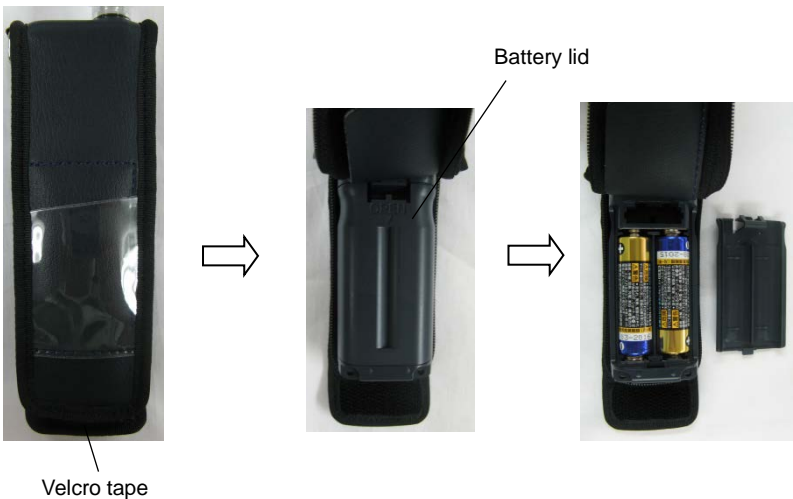

6. Maintenance Check

The Gas Leak Detector is precision measuring equipment. Maintenance in accordance with the following items is imperative for maintaining performance of the Gas Leak Detector and ensuring safety.

In case of dropping the Gas Leak Detector or being wet by using under any conditions other than the normal environment (refer to *Precautions* in *1. Introduction* on page 3 and *Range* in *9. Specifications* on page 23), perform a daily inspection or request a periodic inspection (will be charged).





□ Daily Check

| Items to Check | Description |
|----------------|---------------------------------------------------------------------------------------------------------------------------------------------------------------------------------------------------------------------------------------------------------------------------------------------------------------------------------------------------------------------------------------------------------------------------------------------------------------------------------------------------------------------------------------------------------------|
| Alarm Function | Remove the Dust Filter (refer to <i>Dust Filter Replacement</i> on page 15), attach the Drain Filter and turn ON the power. Then set the detection sensitivity level to 4 and confirm that the alarm lamp (red) flashes and the alarm buzzer will sound when suctioning inspection gas for 0.5 sec. After inspection, turn OFF the power and <u>make sure to attach the Dust Filter</u> . When the alarm sound icon is being displayed and the alarm lamp (red) does not flash or the alarm buzzer does not sound, contact your New Cosmos distributor. |
| Gas Probe | Check the Gas Probe for any wear or damage which would affect operations. If any, replace the Gas Probe. |
| Filter Element | When the Drain Filter is dirty or wet, or the water or liquid is in the Drain Filter, clean out the Drain Filter and replace the Filter Element. (Refer to <i>Filter Element Replacement</i> on page 14.) |
| Battery charge | If the remaining battery charge is low, replace the batteries. (Refer to <i>Battery Replacement</i> on page 16.) |
| Airtightness | Turn ON the power and confirm that "E-P" (refer to <i>Pump Error</i> on page 13) is displayed on the LCD by blocking the inlet of the Gas Probe. If an error occurs, the airtightness is normal. Press the restart pump button. If an error does not occur, the Drain Filter is damaged or the airtight of diaphragm is damaged. Replace the parts or request repairs. |

□ Periodic Inspection

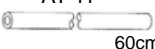
To maintain the accuracy of the Gas Leak Detector, request a periodic inspection at your New Cosmos distributor or directly from New Cosmos at least once a year.

Consumable Parts, Replacement Parts, and Options

| Part Name | Model | Part Code | Remarks | |
|----------------------------|--------------------------------------------------------------------------------------------|---------------------------------------------------------------------------------------------------|---------------------------------------------|------------------------------------------|
| Filter Element (10pcs) | FE-2 | 59160022 | — | |
| Drain Filter | DF-114 | 59070018 | — | |
| Dust Filter (5pcs) | FE-106 | 59160335 | — | |
| Test Gas | EG-10 | 59150200 | — | |
| Gas Collection Set (ATS-6) | Gas Probe | AT-2G | 20524843 | For tubing and coupling |
| | Gas Collector | AT-5  | 20524430 | For tubing and coupling |
| | Annealed Copper Tube | AT-11  60cm | 20524431 59060000 (with tube) | For tubing secluded locations or devices |
| | Sampling Hose | SH-4-05  50cm | 20524531 | Used together with Annealed Copper Tube. |
| Gas Collector | AT-6  | 20524441 | For piping underground or embedded in walls | |
| Gas Collector | AT-7A  | 20524432 | Used together with RP-4. | |
| Telescopic Probe | RP-4  | 20524433 | For tubing underground or on paved surfaces | |
| Instruction Manual | | | | |

7. Troubleshooting

Check for the items in the following table before requesting repair work.

* If operation becomes impossible, try again after removing all of the batteries for a few minutes and insert them again.

■ Gas Leak Detector

| Problem | Cause | Action | Reference |
|----------------------------------------------------------------------------|------------------------------------------|---------------------------------|-------------------------------------------------|
| The power will not turn ON when the "POWER/SENSITIVITY" button is pressed. | The battery polarity is reversed. | Insert the batteries correctly. | <i>Battery Replacement</i> on page 16 |
| | Battery exhaustion. | Replace the batteries. | |
| Displaying the error. | Refer to Error Displays. | | <i>Error Displays</i> on page 13 |
| The buzzer will not sound. | The Gas Leak Detector is in silent mode. | Cancel silent mode. | <i>Silent Mode</i> on page 11 |
| | The alarm buzzer is turned OFF. | Turn ON the alarm buzzer. | <i>Deactivating the Alarm Buzzer</i> on page 12 |

8. Warranty

New Cosmos Electric Company Limited (New Cosmos) offers the following as the sole and exclusive limited warranty available to Customer.

This warranty is in lieu of, and customer waives, all other warranties of any kind or nature, expressed or implied, including without limitation, any warranty for merchantability or fitness for a particular purpose. The remedies set forth herein are exclusive.

New Cosmos warrants to the original purchaser and no other person or entity (customer) that gas detection product supplied by New Cosmos shall be free from defects in materials and workmanship for a period of one (1) year from the date of purchase. This warranty does not include consumables, such as fuses, filters, etc. Certain other accessories not specifically listed here may have different warranty periods.

After examination of allegedly defective product return to New Cosmos, with freight prepaid, should the product fail to conform to this warranty, customer's only remedy and New Cosmos's only obligation shall be, at New Cosmos's sole option, replacement or repair of such non-conforming product or refund of the original purchase price of the non-conforming product. In no event will New Cosmos be liable for any other special, incidental or consequential damages or losses of any kind whatsoever, including but not limited to, loss of anticipated profits and any other loss caused by reason of non-operation of the product.

This warranty is valid only if the product is maintained and used in accordance with New Cosmos's instructions and /or recommendations. New Cosmos shall be released from all obligations under this warranty in the event repairs or modifications are made by persons other than its own or authorized service personnel or if the warranty claim results from physical abuse or misuse of the product.

9. Specifications

| | |
|------------------------------------------|-----------------------------------------------------------------------------------------------------------------------------------------------------------|
| Model | XP-704III |
| Target Gas | R-22, R-32, R-404A, R-407C, R-600a, R-410A, R-134a, R-290, HFO-1234yf |
| Detection Principle | Hot-wire semiconductor sensor (Refer to page 22.) |
| Gas Sampling Method | Extractive type |
| Detectable Leak Rate (annual) | R-22: 2.84[g], R-32: 1.71[g], R-404A: 3.30[g], R-407C: 3.12[g], R-600a: 1.91[g] R-410A: 2.82[g], R-134a: 20.09[g], R-290: 1.45[g], HFO-1234yf: 3.74[g] |
| Detectable Gas Concentration | 5 ppm (R-134a: 30ppm) |
| Response Time | Within 10 seconds |
| Rated Power Supply | Size AA alkaline batteries (LR6) x 2 |
| Battery Life *1 | Approx. 12 hours (with size AA alkaline batteries at 25 degrees C) |
| Degree of Protection *2 | Equivalent to IP22 *3 |
| Operating Pressure Range | Atmospheric pressure (800 to 1100 hPa) |
| Operating Temperature and Humidity Range | 0 to 40 degrees C Less than 85% RH (with no condensation) |
| Compliance | EMC directive (2014/30/EU/SI 2016 No.1091) and RoHS directive (2011/65/EU+(EU)2015/863/SI 2012 No.3032) |
| Dimensions | Approx. 38 (W) x 130 (H) x 32 (D) mm (excluding protrusions) |
| Weight | Approx. 190g (including batteries and soft case) |

*1: The battery life may vary based on the environmental conditions, operating conditions, storage time, battery manufacturer, etc.

*2: While the Gas Leak Detector is inside the soft case.

*3: "Equivalent to IP22" means that protection is provided against the approach of a finger to any hazardous product location (IP2x) and that protection is provided against the negative influence on the product interior from water drops falling within 15 degrees of perpendicular on both sides of the exterior of the product for 2.5 minutes each in four location (for a total of 10 minutes) (IPx2).

10. Detection Principle

- Hot-wire Semiconductor Sensor

When combustible gases react with oxygen absorbed on the surface of the semiconductor, free electrons increase in the semiconductor. As a result, the resistance of the semiconductor decreases. This resistance change is read as differential voltage using a bridge circuit for gas detection purpose. This type of sensor is very sensitive and thus suitable for low concentration gas detection.

Additional copies of this instruction manual may be purchased.
Contact New Cosmos or its authorized representative for ordering.
The contents of this manual are subject to change without notice.

Authorized representative:

Manufacturer:

NEW COSMOS ELECTRIC CO., LTD.
2-5-4 Mitsuya-naka, Yodogawa-ku,
Osaka 532-0036, Japan
www.newcosmos-global.com

NEW COSMOS ELECTRIC CO., LTD.