



Semiconductor Manufacturing
Gas Detector

■ XP-703DⅢ

Gas Leak Detector Instruction Manual

This instruction manual explains the use of three models listed on the left.

- Keep this Instruction Manual available for quick reference when needed.
- Read this Instruction Manual and thoroughly understand before using the product.



NEW COSMOS ELECTRIC CO., LTD.

Table of Contents

Included in this Package	1
1. Introduction	2
Symbols	2
Safe Operation	3
2. Part Names and Functions	4
3. Operating Procedure	7
Attachment of Drain Filter	7
Operating Procedure	8
Silent Mode (No Operation Sound)	11
Deactivating the Alarm Buzzer	12
Lighting the Backlight	12
4. Error Displays	13
5. Replacement of Consumable Parts	14
Filter Element Replacement	14
Battery Replacement	15
6. Maintenance Check	16
Daily Check	16
Periodic Inspection	16
Consumable Parts, Replacement Parts, and Options	17
7. Troubleshooting	18
8. Warranty	19
9. Specifications	20
10. Detection Principle	21

— Included in this Package —

The package includes the items listed in the following table. Before using the Gas Leak Detector, be sure to check that all items have been provided. Every precaution has been taken in preparing the Gas Leak Detector. However, if any items are missing or damaged, please contact your New Cosmos distributor. Replacements for any missing or damaged items will be sent.

Name	Quantity
Gas Leak Detector (with soft case)	1
DF-114 Drain filter	1
Replacement FE-2 filter element	1
AT-2B Attachment	1
Hand strap	1
Size AA alkaline batteries	2
Instruction Manual	1
Operation guide	1
Inspection report	1

1. Introduction

Thank you for purchasing a New Cosmos Gas Leak Detector. Please read this Instruction Manual thoroughly before using the Gas Leak Detector to help prevent gas leakage accidents and to aid in safety inspections.



XP-703DIII Gas Leak Detector detects leakage of semiconductor manufacturing gases and when the gas concentration exceeds the set value, a buzzer and lamp provide notification of the gas leakage to help prevent gas leak accidents.

Read and understand thoroughly this Instruction Manual regardless of your experience with using Gas Leak Detectors.

Do not use this Gas Leak Detector for improper purpose. Do not use this Gas Leak Detector in undocumented way in this manual.

Symbols

The following symbols are used for safety purposes:

 DANGER	Indicates an imminently hazardous situation, which will result in death or serious injury if not avoided.
 WARNING	Indicates a potentially hazardous situation, which will result in death or serious injury if not avoided.
 CAUTION	Indicates a potentially hazardous situation, which may result in minor injury or property damage if not avoided.
NOTE	Operational advice and/or instruction.

Safe Operation

Be sure to observe the following to use the product safely and properly.



DANGER

At the time of the detection, the target gas may be discharged from the exhaustion port.

- DANGER. Do not inhale gas.
- DANGER. Keep away from the fire.



WARNING

- Be sure to turn ON the power in clean air. Since zero adjustment is performed automatically, the proper gas concentration will not be displayed when turning on the power in gas atmosphere.
- Do not block the inlet and outlet. Otherwise, it may no be able to detect properly
- Do not allow water or liquids to enter the Gas Leak Detector. It may cause interference to the gas detection and may damage the Gas Leak Detector.
- Make sure that Filter Element is clean. If the Filter Element is dirty or wet, it may no be able to detect properly.
- Do not block the buzzer hole. It will muffle the alarm.
- This Gas Leak Detector does not have an explosion-proof structure. Do not use in hazardous location.





CAUTION

- Remove the batteries if the Gas Leak Detector will not be used for an extended period of time.
- Check the remaining battery charge periodically (approximately once a month) even if the Gas Leak Detector remains unused for an extended period of time. Replace batteries if the batteries are leaking when the remaining battery charge is low.
- Do not disassemble, alter, or change the structure or electric circuits of the Gas Leak Detector. It may affect its performance.
- Do not leave the Gas Leak Detector in hot and humid environment for a long period of time. It may affect its performance.
- Do not use the Gas Leak Detector in places where the temperature or humidity fluctuates greatly. It may affect its performance.
- Keep the Gas Leak Detector away from significant changes in atmospheric pressure. It may affect the performance of or damage the sensor.
- Avoid high mechanical impacts, dropping and throwing the Gas Leak Detector. It may affect its performance.
- In case of dew condensation, conduct an inspection after drying the Gas Leak Detector completely before use.
- Do not use the Gas Leak Detector near silicon sealing agents or in atmosphere containing silicon gas. It may affect its performance.
- The Gas Leak Detector may detect gas or solvent vapors other than the target gas. Consider the inspection environment when using the Gas Leak Detector.
- Detecting high concentration of SO₂ or Cl₂ may decrease the sensor life or increase errors.
- This is a simplified drip-proof Gas Leak Detector by soft case. Avoid as practicably as possible exposure to water.
- Keep away from the wireless applications. The alarm may sound due to the radio waves near the wireless applications.

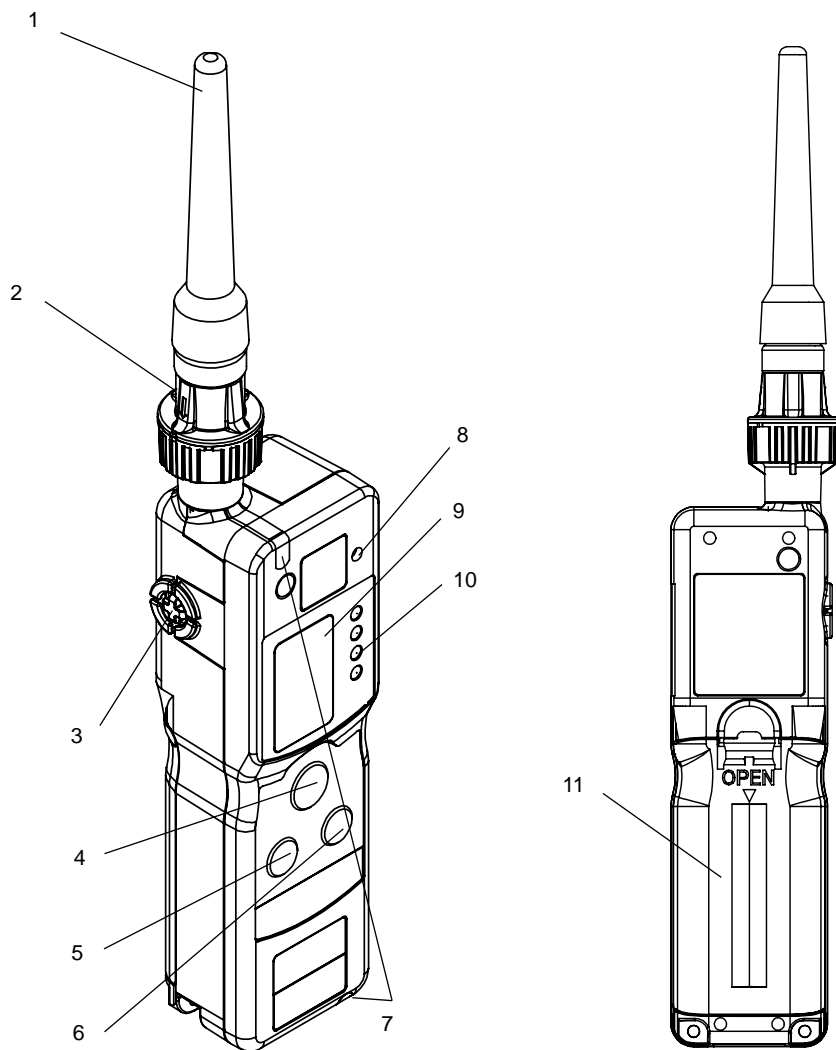
2. Part Names and Functions

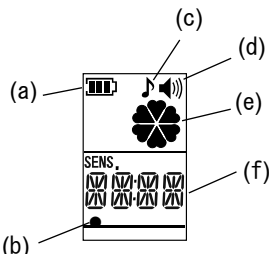

No.	Name	Functions
1	AT-2B Attachment	Gas inlet.
2	DF-114 Drain Filter	Protects the Gas Leak Detector from water, dust, and other foreign matter.
3	Outlet	Gas outlet to exhaust sampled gas.
4	POWER/SENSITIVITY Button	Turns the power ON and OFF. Sets the gas sensitivity level.
5	BUZZER Button	Turns the alarm buzzer and operation sound ON and OFF.
6	ZERO/ RESTART PUMP/ BACKLIGHT Button	Starts Zero Adjustment. Restarts pump operation after a pump error. Lights the LCD backlight.
7	ALARM /ERROR Lamps (red)	Light up or flash when detecting gas leakage. The flashing frequency increases as the concentration of the gas leak increases. The lamps light if the concentration is very high. These lamps also flash when an error occurs in the pump or sensor.
8	Buzzer hole	The buzzer sounds.
9	LCD 	<p>Displays the gas sensitivity and messages.</p> <p>(a) The remaining battery charge is displayed. Battery charge: High Low </p> <p>(b) It indicates the status of zero adjustment.</p> <p>(c) The indicator shows the operation sound. (The indicator is displayed only when the operation sound is turned ON.)</p> <p>(d) The indicator shows the alarm sound. (The indicator is displayed only when the alarm sound is turned ON.)</p> <p>(e) The pump operation is displayed. (The indicator rotates if the pump is operating normally.)</p> <p>(f) The gas sensitivity level and errors are displayed.</p>
10	Gas Sensitivity Lamps (green)	Indicate the gas sensitivity level. There are five gas sensitivity levels.
11	Battery Lid	The cover to the battery compartment.

Soft case



No.	Name	Functions
1	Side Zipper	Open the zipper to replace the batteries.
2	Back Pocket	The Operating Guide is stored here.
3	Inside Pocket	A Replacement Filter Element is stored here.

3. Operating Procedure

Attachment of Drain Filter

Attach the Drain Filter and Attachment to the Gas Leak Detector before use.

- 1) Place the Gas Leak Detector in the soft case, and close the zippers (both sides) and Velcro tape.
(The Gas Leak Detector is in the soft case from the shipment.)
- 2) Insert the Attachment to the Drain Filter.
(The attachment is inserted to the drain filter from the shipment.)
- 3) Turn the Drain Filter clockwise to the Gas Leak Detector and tighten.
(The proper detection cannot be performed unless the Drain Filter is firmly attached.)

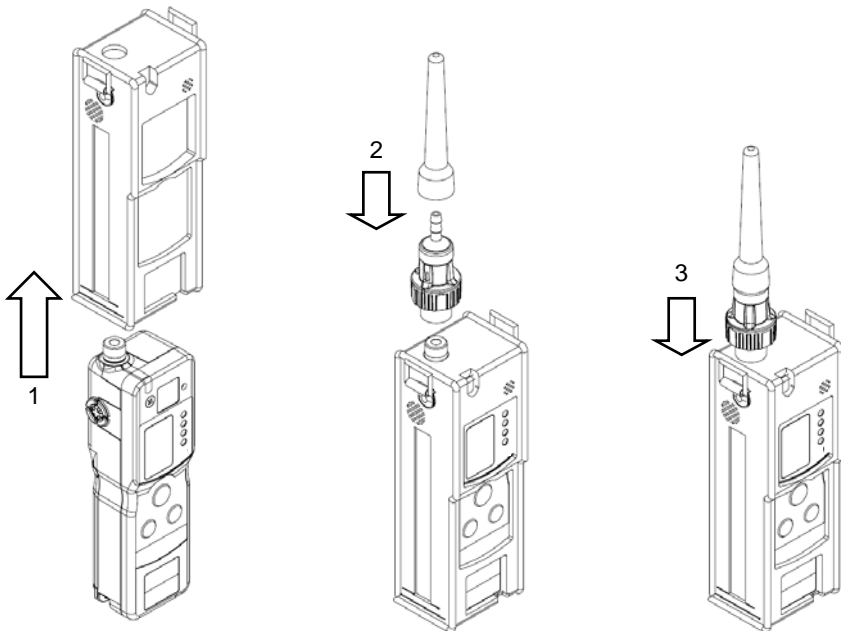

Operating Procedure



WARNING Always perform the daily check before use. (Refer to page 16.)

STEPS

1 Insert batteries

2 Turn ON power

Warm-up

Gas concentration display

3 Detection

4 Turn OFF power

1. Insert the Batteries

There are no batteries in the Gas Leak Detector at the point of purchase. Insert the enclosed batteries into the Gas Leak Detector. (Refer to *Battery Replacement* on page 15.)

2. Turn ON the Power, Warm-up, Display Gas Sensitivity



WARNING Be sure to turn ON the power in clean air. Since zero adjustment is performed automatically, the proper gas concentration will not be displayed when turning on the power in gas atmosphere.

- 1) Press the “POWER/SENSITIVITY” button for approximately one second. The buzzer beeps and the power will be ON.
- 2) “ADJ” is displayed on the LCD while the Gas Leak Detector is warming up. The stability of sensor is indicated with four gas sensitivity lamps (green). As the sensor stabilizes, the flashing lamp moves down in order from the lowest sensitivity level “1”. Before warm-up is completed, the highest sensitivity level “4” lamp will flash. (The maximum warm-up time is three minutes.)

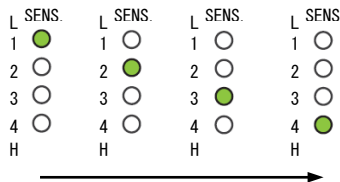

NOTE

If the sensor stabilizes quickly, all of the lamps may not flash one at a time. If the Gas Leak Detector remains unused for an extended period of time, the warm-up time may increase and “E-S” may be displayed on the LCD. (Refer to *Sensor Error* on page 13.)

If sensor error is displayed, cycle the power.

3) When the warm-up operation is completed, the buzzer sounds once, a gas sensitivity lamp (green) lights, and the gas sensitivity level is displayed on the LCD. The gas sensitivity level is set to level “3” immediately after the batteries are inserted. It starts up next time with the same settings of gas sensitivity level.

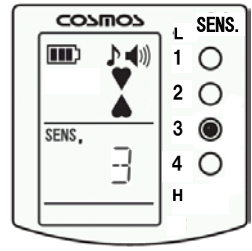

4) The gas sensitivity can be set from four levels in increasing order of sensitivity “4”, “3”, “2” and “1”. The gas sensitivity can be changed as needed.

NOTE • The detected gas concentrations for the gas sensitivity levels are as follows (for hydrogen).
 Level 4: Detects concentration of 1 ppm or less.
 Level 3: Detects concentrations of around 6 ppm.

● **Decreasing the Gas Sensitivity Level**
 Each time pressing the “POWER/SENSITIVITY” button, the buzzer will sound once and the gas sensitivity level will be decreased one level. The lighted gas sensitivity lamp (green) will move up one by one, and the LCD will also display the same sensitivity level as shown on the gas sensitivity lamp.
 When the gas sensitivity level is decreased beyond “1”, the level will return to level “4”.

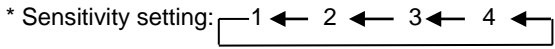
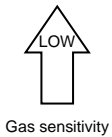
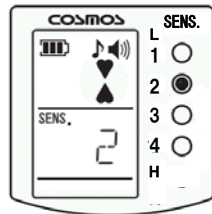

NOTE Press the POWER/SENSITIVITY button for more than 3 seconds to turn OFF the power.

● **Increasing the Gas Sensitivity Level**
 Each time pressing the “POWER/SENSITIVITY” button twice (double-click), the buzzer will sound twice and the gas sensitivity level will be increased one level. The lighted gas sensitivity lamp (green) will move down one by one, and the LCD will also display the same sensitivity level as shown on the gas sensitivity lamp.
 When the gas sensitivity level is increased beyond “4”, the level will return to level “1”.

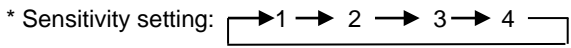
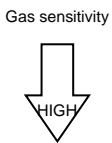
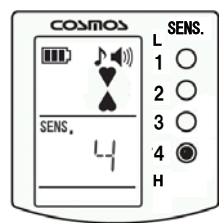

3. Zero Adjustment



CAUTION

- It needs to perform “Zero Adjustment” to use at sensitivity level “4”. Due to its high sensitivity, it is too susceptible to the ambient environment to detect gas appropriately.
- It can be used even if the “Zero Point Status” (dot mark) is blinking or off, but it may not be able to detect gas properly.

Before detection, follow the steps in accordance with the “Zero Point Status” (dot mark) on the bottom left corner of LCD.

Lighting: Zero Adjustment is not necessary for using at sensitivity level “3”, “2” or “1”. It needs to perform Zero Adjustment to use at sensitivity level “4”.

Blinking: Perform Zero Adjustment.

However, when the lighting on and off repetitively may seem to be blinking. In this case, turn off the power once and then turn on again.

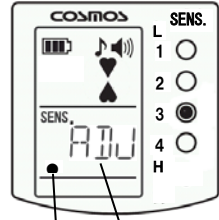

“ADJ” is displayed

Zero Point Status

Lighting Off: Zero Adjustment cannot be performed. (There is a possibility of the presence of gas.) Wait until it blinks. If it does not blink, after a few minutes, turn off the power once and then turn on again.

To perform Zero Adjustment, press and hold the “ZERO/RESTART PUMP/BACKLIGHT” button for more than 3 seconds.

- If Zero Adjustment is able to be performed, “ADJ” will be displayed on the LCD with “blip” sound for 3 seconds, and then it will return to display the gas sensitivity level.
- If Zero Adjustment is not able to be performed, the buzzer sound will beep and it remains to display the gas sensitivity level on the LCD.

4. Detection



DANGER

- Alarm Buzzer
If the alarm buzzer sounds or the alarm lamp (red) lights up /flashes, take necessary measures.
- If the remaining battery charge indicator  appears, replace the batteries in a non-hazardous clean air location promptly. (Refer to *Battery Replacement* on page 15.)
If “E-B” is displayed on the LCD (refer to *Battery Alarm* on page 13), the buzzer will start sounding continuously and the Gas Leak Detector will not be working. Early battery replacement is recommended.

Move the Attachment towards the detection place. When the Gas Leak Detector detects a gas leak, the alarm lamp (red) will flash and the alarm buzzer will start sounding continuously. As the gas concentration increases, the alarm buzzer will sound more frequently and will change to continuous sound. (The alarm buzzer will sound faster as approaching the location of gas leak.)
 The alarm lamp (red) will flash and then light continuously in sync with the alarm buzzer.

NOTE The alarm buzzer can be turned ON and OFF as needed. (Refer to *Deactivating the Alarm Buzzer* on page 12.)

5. Turn OFF the Power

CAUTION • Make sure that the alarm buzzer is not sounding before turning OFF the power. If the alarm buzzer is sounding when turning OFF the power, a sensor error (refer to page 13) may occur at the next use.

- In case of detecting high concentration gas, take in clean air for several minutes before turning OFF the power, to prevent to affect performance.

After the detection, press the “POWER/SENSITIVITY” button for 3 seconds. The buzzer sounds three times and the power will go OFF.

- Automatic Gas Exhaust Mode

If there is any gas remaining in the Gas Leak Detector when the power is turned OFF, it will enter automatic gas exhaust mode. When it enters automatic gas exhaust mode, the buzzer will sound once, “60” will be displayed on the LCD, and a countdown will start (59, 58...).

- Procedure after Sampling High Concentrations of Gas

If a high concentration gas of any in the following table is detected, leave the Gas Leak Detector in clean air for a certain period of time before turning OFF the power. Turning OFF the power immediately may affect performance. Also, a sensor error (refer to page 15) may occur.

Silent Mode (No Operation Sound)

CAUTION In silent mode, the Gas Leak Detector produces no sounds at all except for errors and the battery alarm. It will be impossible to confirm operation audibly. Avoid using silent mode unless it is absolutely necessary, and make sure to release silent mode after use.

Operation sound indicator Alarm sound indicator

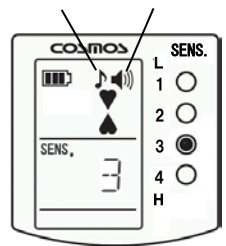

Press the “BUZZER” button for 3 seconds when the power is ON to enter silent mode.

In silent mode, the operation sound and alarm buzzer will not function and the operation sound and alarm sound indicators on the LCD will not be displayed. However, the error alarm buzzer and battery alarm buzzer (in unusable state) will sound. (Refer to *Error Displays* on page 13 and to *Battery Replacement* on page 15.)

To release silent mode, press the “BUZZER” button for 3 seconds. The alarm buzzer cannot be turned ON or OFF unless silent mode is released. (Refer to *Deactivating the Alarm Buzzer* on page 12.)

NOTE

Silent mode will remain in effect even when the power is turned OFF unless silent mode is released or unless the batteries are replaced.

Deactivating the Alarm Buzzer

The alarm buzzer for gas detection can be turned ON or OFF. Press the “BUZZER” button when the power is ON, the buzzer will sound once and the alarm buzzer sound will be turned ON/ OFF. The alarm sound indicator on the LCD will light (buzzer ON) or go out (buzzer OFF).

NOTE

- When the power is turned ON again, the alarm buzzer sound setting will be the same as before the power was turned OFF. However, the alarm buzzer sound will be turned ON after the battery replacement.
- The alarm buzzer sound cannot be turned ON or OFF while in silent mode.

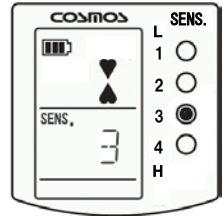

Alarm sound indicator

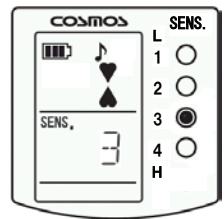
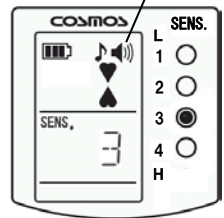

Lighting the Backlight

The LCD backlight lights by pressing the “ZERO/RESTART PUMP/ BACKLIGHT” button.





It also lights automatically for approximately 15 seconds when an error occurs.

NOTE

To extend the battery life, the backlight will not light up when the remaining battery charge indicator is at the lowest level (battery outline only).

4. Error Displays

If an error occurs with the Gas Leak Detector, the error lamps will flash, an error will be displayed on the LCD, and the buzzer will sound repeatedly. The major errors are described in the following table. Take the corresponding action given in the table.

Error	Error Display	Cause	Solution
Sensor Error	(Error lamps flash) 	There may have been gas present when the power was turned ON.	Turn ON the power again in clean air. If the same error occurs even after turning ON the power several times, there may be a problem with the sensor. Request repairs.
Pump Error	(Error lamps flash) 	Water or liquid may have been sampled or the inlet may be blocked.	Remove the water or liquid. (Refer to <i>Filter Element Replacement</i> on page 14.) If the same error occurs even after pressing the "ZERO/RESTART PUMP/BACKLIGHT" button, the pump may have failed, or water or liquid may have been in the Gas Leak Detector. Request for repairs.
Battery Alarm	(Error lamps flash) 	The battery voltage is too low to operate.	Replace batteries. (Refer to <i>Battery Replacement</i> on page 15.)
Detector Error	(Error lamps flash) 	A problem may have occurred in the Gas Leak Detector.	Request for repairs.

5. Replacement of Consumable Parts

Filter Element Replacement

When the Filter Element is dirty or wet, or when the water or liquid is inside the Drain Filter, clean out the Drain Filter and replace the Filter Element.

- CAUTION**
- Do not replace the Filter Element while the Gas Leak Detector is operating. Dust or other foreign matter may enter the Gas Leak Detector.
 - Mount the Filter Element correctly. If the Filter is not in place properly, it will not function properly and will not be able to detect correctly.
 - Attach the filter case securely. If the filter case is loose, water or other foreign matter may leak into the Gas Leak Detector.
 - If water or liquid reaches inside the Gas Leak Detector through the Filter Element, it is in need of repair. It will not be able to detect correctly.

NOTE Do not push or poke the Filter Element. It may damage the waterproof structure.

- 1) Turn the filter case counterclockwise and remove it.

CAUTION If water, dust, or other foreign matter is in the Drain Filter, be careful not to enter into the Gas Leak Detector.

- 2) Remove the O-ring from inside the cap.
- 3) Replace the Filter Element with a new filter.

NOTE Clean the inside of the cap and filter case with a dry cloth as needed. Remove water or liquid completely and dry the parts before replacing with a new Filter Element.

CAUTION Make sure to attach FE-2 Filter Element between the Cap and Filter Case.

- 4) Attach the O-ring, put the filter case back together and reassemble.

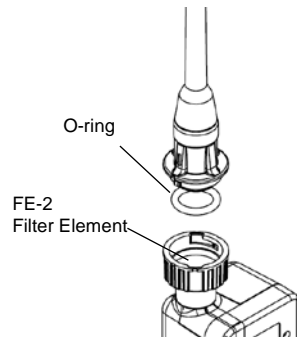
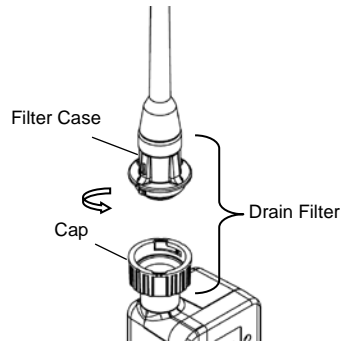

Battery Replacement

- NOTE** • Make sure to use size AA LR6 alkaline dry cell batteries.

When the remaining battery charge indicator changes to  , the battery charge is low.

When the battery voltage drops and reaches to the final voltage, “E-B” (refer to *Battery Alarm* on page 13) will be displayed on the LCD and the Gas Leak Detector will not be working. Replace the batteries.

NOTE

- Use the same kind of batteries.
- Always replace two batteries at the same time.
- Due to the characteristics of the batteries, the battery life will be shorter when the surrounding temperature is lower than room temperature.

- 1) Open the Velcro tape of the soft case and open the side zipper.
- 2) Open the battery lid of the back of the Gas Leak Detector and install two new batteries (size AA alkaline) as shown on the bottom of the compartment.
- 3) Close the battery lid firmly.
- 4) Zip the right and left of the soft case and close the Velcro tape.

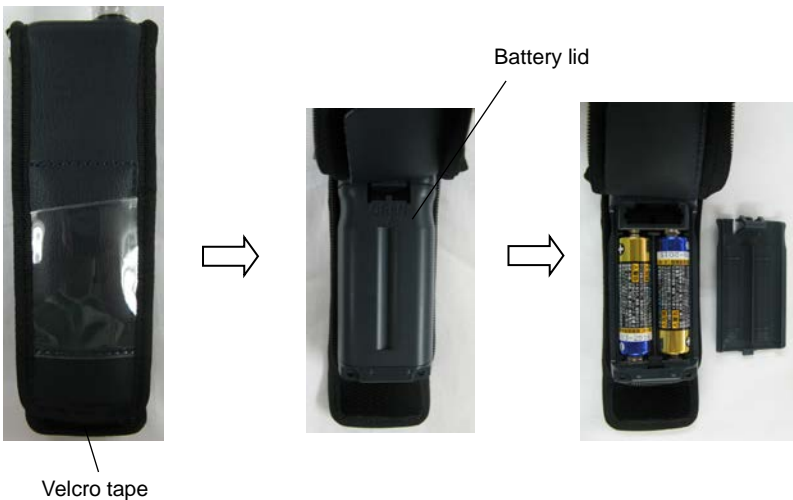

6. Maintenance Check

The Gas Leak Detector is precision measuring equipment. Maintenance in accordance with the following items is imperative for maintaining performance of the Gas Leak Detector and ensuring safety.

In case of dropping the Gas Leak Detector or being wet by using under any conditions other than the normal environment (refer to *Cautions* in 1. *Introduction* and *Range* in 9. *Specifications*) perform a daily inspection or request a periodic inspection (will be charged).

■ Daily Check

Items to Check	Description
Alarm Function	Attach the Drain Filter and turn ON the power. After the warming up operation, set the gas sensitivity level to "3" and confirm that the alarm lamp (red) flashes and the alarm buzzer will sound by suctioning inspection gas for half a second. If the alarm sound indicator is displayed on the LCD and the alarm lamp (red) will not flash or the alarm buzzer will not sound, contact your New Cosmos distributor.
Attachment	Check the Attachment for any wear or damage which may affect operations. If any, replace with a new Attachment.
Filter Element	When the Drain Filter is dirty or wet, or the water or liquid is in the Drain Filter, clean out the Drain Filter and replace the Filter Element. (Refer to <i>Filter Element Replacement</i> on page 14.)
Battery Charge	If the remaining battery charge is low, replace the batteries. (Refer to <i>Battery Replacement</i> on page 15.)
Airtightness	Turn ON the power and confirm that "E-P" (refer to <i>Pump Error</i> on page 13) is displayed on the LCD by blocking the inlet of the Attachment. If an error occurs, the airtightness is normal. Press the restart pump button. If an error does not occur, the Drain Filter is damaged or the airtight of diaphragm is damaged. Replace the parts or request repairs.

■ Periodic Inspection

To maintain the accuracy of the Gas Leak Detector, request a periodic inspection at your New Cosmos distributor or directly from New Cosmos at least once a year.

Consumable Parts, Replacement Parts, and Options

Part Name	Model	Part Code	Remarks
Filter Element (10pcs)	FE-2	59160022	—
Drain Filter	DF-114	59070018	—
Inspection Gas	EG-10D	59150300	
Attachment	AT-2B	20524489	For tubing and coupling
Instruction Manual			

7. Troubleshooting

Check for the items in the following table before requesting repair work.

- * If operation is impossible, try again after removing all of the batteries for a few minutes and insert them again.

■ Gas Leak Detector

Problem	Cause	Action	Reference
The power will not turn ON by pressing the POWER/SENSITIVITY button.	The battery polarity is reversed.	Insert the batteries correctly.	<i>Battery Replacement</i> on page 15
	Battery exhaustion.	Replace the batteries.	
Displaying the error.	Refer to <i>Error Displays</i> .		<i>Error Displays</i> on page 13
The buzzer will not sound.	The Gas Leak Detector is in silent mode.	Release silent mode.	<i>Silent Mode</i> on page 11
	The alarm buzzer is turned OFF.	Turn ON the alarm buzzer.	<i>Deactivating the Alarm Buzzer</i> on page 12

8. Warranty

New Cosmos Electric Company Limited (New Cosmos) offers the following as the sole and exclusive limited warranty available to Customer.

This warranty is in lieu of, and customer waives, all other warranties of any kind or nature, expressed or implied, including without limitation, any warranty for merchantability or fitness for a particular purpose. The remedies set forth herein are exclusive.

New Cosmos warrants to the original purchaser and no other person or entity (customer) that gas detection product supplied by New Cosmos shall be free from defects in materials and workmanship for a period of one (1) year from the date of purchase. This warranty does not include consumables, such as fuses, filters, etc. Certain other accessories not specifically listed here may have different warranty periods.

After examination of allegedly defective product return to New Cosmos, with freight prepaid, should the product fail to conform to this warranty, customer's only remedy and New Cosmos's only obligation shall be, at New Cosmos's sole option, replacement or repair of such non-conforming product or refund of the original purchase price of the non-conforming product. In no event will New Cosmos be liable for any other special, incidental or consequential damages or losses of any kind whatsoever, including but not limited to, loss of anticipated profits and any other loss caused by reason of non-operation of the product.

This warranty is valid only if the product is maintained and used in accordance with New Cosmos's instructions and /or recommendations. New Cosmos shall be released from all obligations under this warranty in the event repairs or modifications are made by persons other than its own or authorized service personnel or if the warranty claim results from physical abuse or misuse of the product.

9. Specifications

Model	XP-703DIII
Target Gas	H ₂ , AsH ₃ , B ₂ H ₆ , SiH ₄ , PH ₃
Detection Principle	Hot-wire semiconductor sensor (Refer to page 21.)
Gas Sampling Method	Extractive type
Detectable Leak Rate	H ₂ : 5.07×10^{-7} , AsH ₃ : 2.53×10^{-7} , B ₂ H ₆ : 1.01×10^{-7} , SiH ₄ : 2.53×10^{-7} , PH ₃ : 1.52×10^{-7}
Detectable Gas Concentration	H ₂ : 1.0ppm, AsH ₃ : 0.5ppm, B ₂ H ₆ : 0.2ppm, SiH ₄ : 0.5ppm, PH ₃ : 0.3ppm
Response Time	Within 10 seconds (for 300% of detectable gas concentration)
Rated Power Supply	Size AA alkaline batteries (LR6) x 2
Battery Life ^{*1}	Approx. 12 hours (with size AA alkaline batteries at 25 degrees C)
Degree of Protection ^{*2}	Equivalent to IP22 ^{*3}
Operating Pressure Range	Atmospheric pressure (800 to 1100hPa)
Operating Temperature and Humidity Range	0 to 40 degrees C / less than 85% RH (with no condensation)
Compliance	EMC directive (2014/30/EU/SI 2016 No.1091) and RoHS directive (2011/65/EU+(EU)2015/863/SI 2012 No.3032)
Dimensions	Approx. 38 (W) x 130 (H) x 32 (D) mm (excluding protrusions)
Weight	Approx. 190g (including batteries and soft case)

*1: The battery life may vary based on the environmental conditions, operating conditions, storage time, battery manufacturer, etc.

*2: While the Gas Leak Detector is inside the soft case.

*3: "Equivalent to IP22" means that protection is provided against the approach of a finger to any hazardous product location (IP2x) and that protection is provided against the negative influence on the product interior from water drops falling within 15° of perpendicular on both sides of the exterior of the product for 2.5 minutes each in four location (for a total of 10 minutes) (IPx2).

10. Detection Principle

- Hot-wire Semiconductor Sensor

When combustible gases react with oxygen absorbed on the surface of the semiconductor, free electrons increase in the semiconductor. As a result, the resistance of the semiconductor decreases. This resistance change is read as differential voltage using a bridge circuit for gas detection purpose. This type of sensor is very sensitive and thus suitable for low concentration gas detection.

Additional copies of this instruction manual may be purchased.
Contact New Cosmos or its authorized representative for ordering.
The contents of this manual are subject to change without notice.

Authorized representative:

Manufacturer:

NEW COSMOS ELECTRIC CO., LTD.
2-5-4 Mitsuya-naka, Yodogawa-ku,
Osaka 532-0036, Japan
www.newcosmos-global.com

NEW COSMOS ELECTRIC CO., LTD.