

Carbon Dioxide Detector

KS-7R

Instruction Manual

- Keep this manual for easy reference.
- Carefully read this manual prior to use.
- This manual describes the standard model. If your unit has end-user-specific options, this manual will be superseded by your delivery specifications.



NEW COSMOS ELECTRIC CO., LTD.

Instruction Manual No.
GAE-139-03
September 2022

Table of Contents

1. Introduction	1
2. General Precautions	2
3. Package Contents	3
4. Unit Dimensions and Components	4
4-1. Outer Appearance	4
4-2. Inner Components	5
5. Installation	6
6. Wiring	9
6-1. Pin Terminal/Insulated Sleeve Installation	10
6-2. Wire Connection/Disconnection to/from Terminal Block	11
6-2-1. Power Terminal Block	11
6-2-2. External Output Terminal Block	11
6-3. Cable Tie Installation	11
7. Operation	12
7-1. Precautions before Use	12
7-2. Operating Procedure	12
7-3. LCD Operation	14
7-3-1. LCD	14
7-3-2. Normal Operation Status	14
7-3-3. Full Scale and Alarm Set Values Display	15
7-3-4. Peak Value Display and Reset	15
7-3-5. Operation during Gas Alarm	15
7-4. User Mode	16
7-4-1. User Mode Operation	16
7-4-2. Switching Maintenance Mode On/Off [Mode 1]	17
7-4-3. Zero Adjustment [Mode 2]	18
7-4-4. Air Adjustment [Mode 3]	18
7-4-5. Alarm Test [Mode 4]	19
7-4-6. Alarm Event History [Mode 5]	20
7-4-7. Clock Setting [Mode 6]	21
7-5. Maker Mode	22
7-5-1. Maker Mode Activation	22
7-5-2. Alarm Set Value Change	23
8. Maintenance	24
8-1. Inspection Contents and Frequency	24
8-2. Clock Battery Replacement	26
9. Troubleshooting	28
10. Specifications	30
11. Warranty	31
12. Expected Sensor Life	31
13. Detection Principle	32
14. Glossary	33
15. Proper Product Disposal at End of Life	34

1. Introduction

Thank you for purchasing the New Cosmos KS-7R carbon dioxide detector.

To ensure safe and reliable operation, please read this instruction manual prior to use.

This unit detects carbon dioxide and is intended for use in a non-hazardous indoor area, e.g., office, laboratory, or clean room, for the early detection of a gas leak.

The unit will relay the gas concentration value as an analog signal (4-20mADC) to external equipment while simultaneously displaying the gas concentration value on its display.

This unit monitors carbon dioxide levels, and when they reach a preset level, the unit will produce audio-visual alarms and activate relay contacts.

SYMBOLS

This manual uses Danger, Warning, Caution and Note symbols to draw attention to procedures, materials, methods, and processes, which require particular attention.

 **DANGER** : Indicates an imminently hazardous situation that can result in death or serious injury.

 **WARNING** : Indicates a potentially hazardous situation that may result in death or serious injury.

 **CAUTION** : Indicates a hazardous situation that may result in minor injury or property damage.

NOTE : Provides information on product handling.

2. General Precautions

- Carefully read this manual prior to use.
- Follow the precautions below to ensure safe operation.
- Only use this product in accordance with the applicable laws and regulations.
- Only a qualified electrician with knowledge of wiring and installation procedures should perform wiring and installation.

WARNING

- In the event of a gas alarm, follow the safety procedures in accordance with your company's regulations.
- This product is not explosion-proof and should not be installed in a hazardous area.
- Secure the cover by tightening the two fastening screws. Proper gas detection is not possible if the cover is not tightly closed.

CAUTION

- Do not disassemble, modify, or alter the structure of this unit or its electrical circuits. Doing so may compromise the performance of the product.
- This product is not drip-proof equipment and should be kept away from water.
- Condensation inside the product may cause a device failure. If used continuously in a high humidity environment, take measures to prevent condensation.
- The product's analog output resolution is 1,000 steps. Because of the difference in resolution or number of displayed gas concentration digits between this product and high-layer monitoring software, or connected impedance, some errors in displayed gas concentration value may be observed.
If the fault threshold needs to be set via analog output, set it to 1.0 mA.

NOTE

Operation during power outage

In the event of a power outage during operation, the detector will automatically resume operation once power is restored, provided the main power switch, under the cover, is in the on (up) position.

3. Package Contents

The following items are included in a standard package. If any items are missing or damaged, please contact New Cosmos or its authorized representative for replacement.

Item	Quantity	Description
CO ₂ detector (KS-7R)	1	
Mounting screw	2	M5x12 with spring washer (wall mounting)
Cable tie	1	To be used to bundle electric cables
Pin terminal	9	To be crimped to cables and inserted into the terminal block
Insulating sleeve	9	To be installed in a crimped pin terminal to provide insulation
Instruction manual	1	This manual
Inspection certificate	1	

4. Unit Dimensions and Components

4-1. Outer Appearance

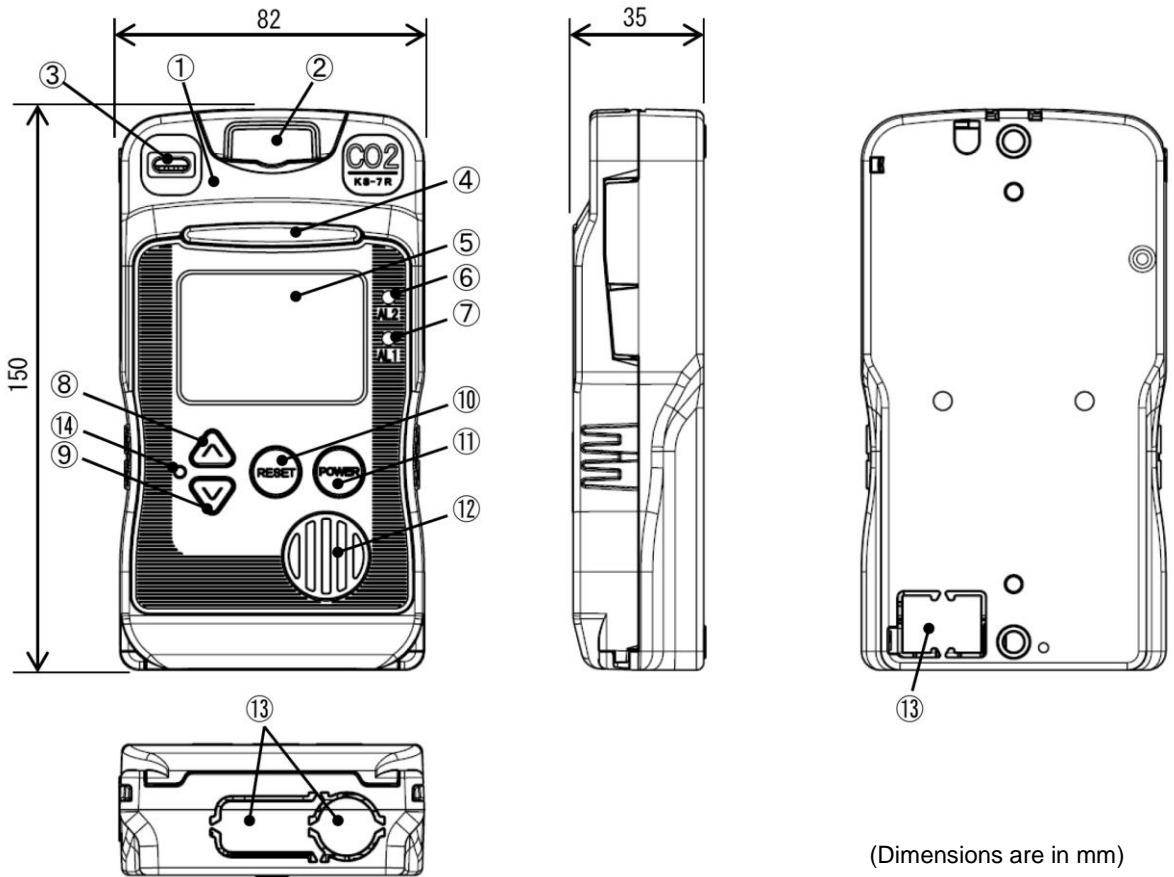

(Dimensions are in mm)

Item	Component	Description/Function
1	Cover	Slide up and lift the cover to access to the main power switch and to wire external cables. This cover is normally closed.
2	Screw cover	Houses one mounting screw, and two fastening screws that attach the cover to the unit. This cover is normally closed.
3	Gas detection port	Gas inlet to the CO ₂ sensor.
4	Status indicator	During normal operation all three green internal LEDs are lit. In the event of an 1 st /2 nd stage alarm, four internal amber/red LEDs light sequentially.
5	LCD	Displays CO ₂ concentration, parameter values, error code , and status icons.
6	AL2 alarm LED, red	Flashes red in the event of a 2 nd stage alarm. The LED will become solid if reset by pressing the RESET button.
7	AL1 alarm LED, amber	Flashes amber in the event of a 1 st stage alarm. The LED will become solid if reset by pressing the RESET button.
8	▲ (Up) button	During normal operation, press to display the highest peak value of gas concentration after powering-up on the LCD. Used for making settings in combination with other buttons.
9	▼ (Down) button	Used for making settings in combination with other buttons.

Item	Component	Description/Function
10	RESET button	During normal operation, press to display the full scale and alarm set values. Used for muting an on-going audio alarm.
11	POWER button	Press and hold for three seconds to turn on/off the detector.
12	Speaker opening	Opening for audio.
13	Cable entry (3 places)	Make a cutout (cable entry) with a nipper to connect external cables to the terminals.
14	Maintenance button	Recessed button used for making settings.

4-2. Inner Components

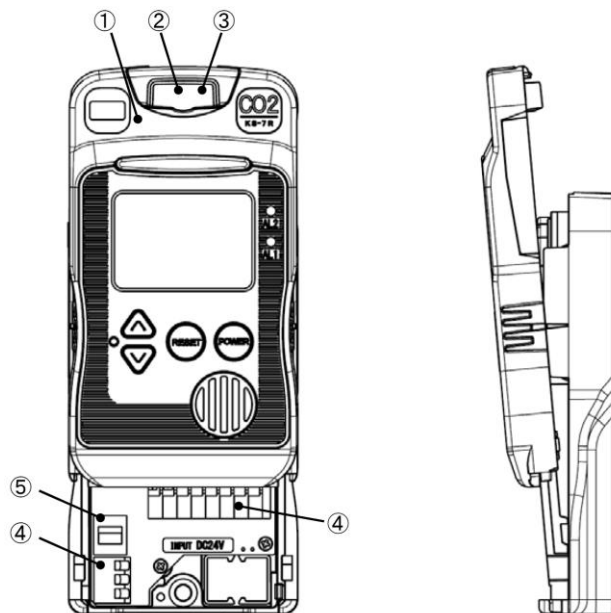

Item	Component	Description/Function
1	Cover	Slide up and lift the cover to access to the main power switch and to wire external cables. This cover is normally closed.
2	Screw cover	Houses one mounting screw, and two fastening screws that attach the cover to the unit. This cover is normally closed.
3	Fastening screw (2 places)	Located under the screw cover. Screws that attach the screw cover to the unit.
4	Terminal block	Connect to external wiring.
5	Main power switch	Turns on/off the main power.

5. Installation

WARNING

- This product is not explosion-proof and should not be installed in a hazardous area.
- Do not use the product at an area where the CO₂ concentration is less than 360 ppm.

CAUTION

- Avoid strong mechanical shock, impact or vibration to the detector by dropping or bumping. Failure to do so may impair the performance of the detector.
- Do not install the detector in the following conditions.
 - Outdoors
 - Exposure to water spray
 - Outside the following operating temperature/humidity
 - 10 to +50°C (no rapid temperature change)
 - 0 to 85% RH (no condensation)
 - Presence of corrosive gas
 - Exposure to impact or vibration
 - Presence of high frequencies or a magnetic field
 - Exposure to electrical noise
 - Exposure to dust
 - Exposure to high winds (higher than 6 m/s or 13.4 mph)
- Install the detector in a location that ensures easy access for maintenance.
- Install the detector vertically with the sensor on top. Proper gas detection is not possible if installed inverted, at an angle, or horizontally.
- CO₂ is heavier than air, so the recommended sensor height is 150 cm (head height) unless otherwise required by applicable laws or regulations. Install the unit with its gas detection port free from obstructions.
- Secure the cover by tightening the two fastening screws. Proper gas detection is not possible if the cover is not tightly closed.
- Do not use or store the detector where alcohols, acetone, or volatile oil is present. That may compromise the product's detection performance.
- Do not use or store the detector where chlorine or corrosive gas is present. That may compromise the product's detection performance.
- Exposure to alkali metals especially salt spray) or other inorganic elements may contaminate the sensor and compromise the detection performance.
- Accurate measurement is not possible, if installed beyond standard sea-level atmospheric pressure range (e.g. at high-altitude).

NOTE

- Leave a distance of more than 30 mm from each side of the detector for removal purpose.
- Leave a distance of more than 50 mm from the top of the detector to allow the cover to slide open.
- Leave enough space for cable wiring below the detector.

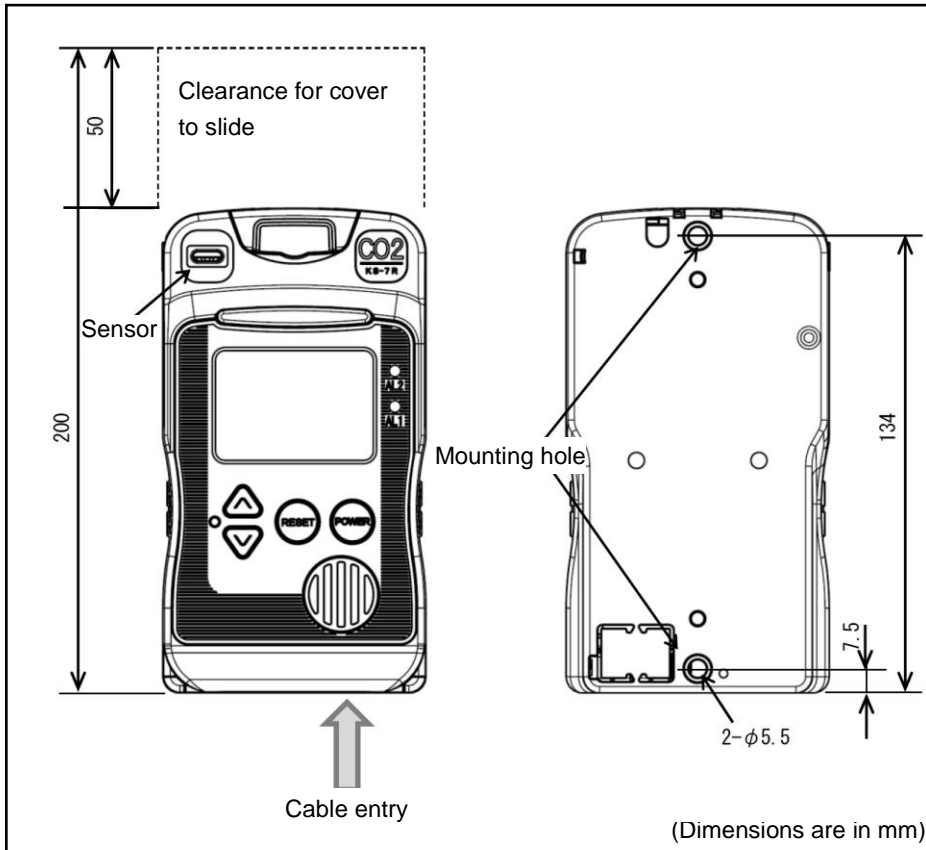

Wall-mount the detector using two M5 mounting screws (pitch: 134) according to the following procedure.

1. Open the screw cover.
2. Loosely install the mounting screw (top).
3. Loosen the two fastening screws.
4. Slightly pull the cover forward.

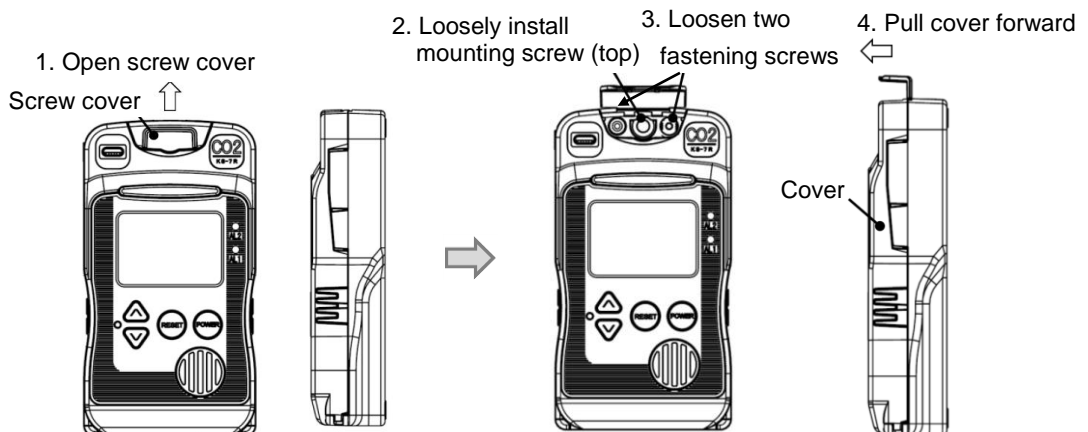

5. Slide the cover up (cover is open).
6. Firmly tighten the mounting screw (bottom) to secure the detector to the wall.
7. Slide the cover down (cover is closed).

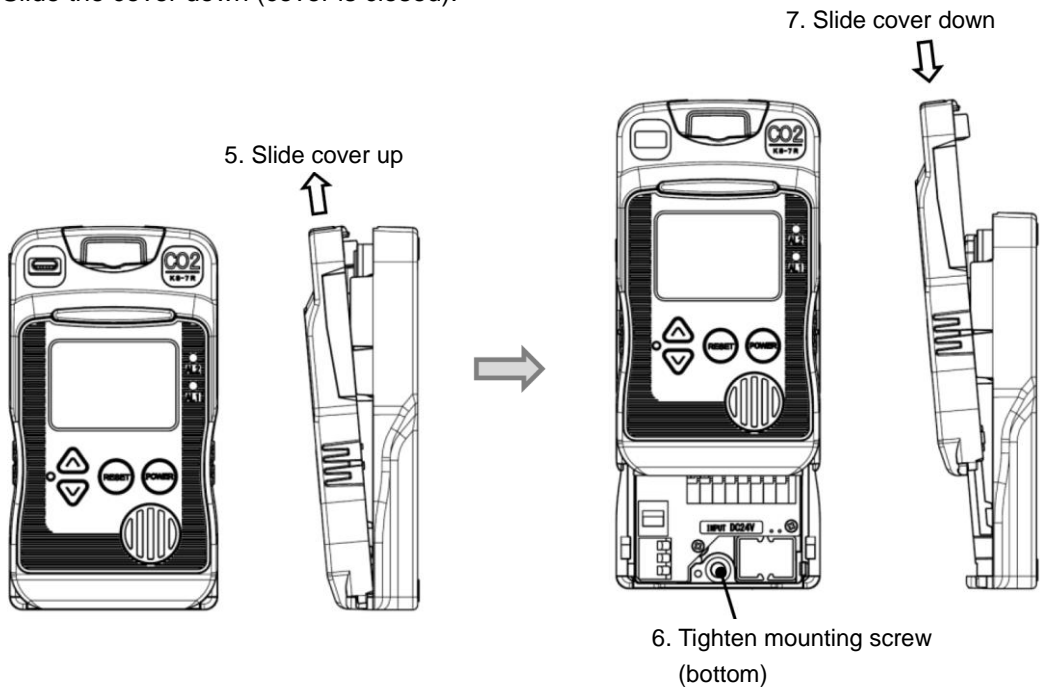

8. While pressing the cover down toward the case,
9. Tighten the mounting screw (top).
10. Secure the screw cover to the case with the two fastening screws.
11. Close the screw cover.

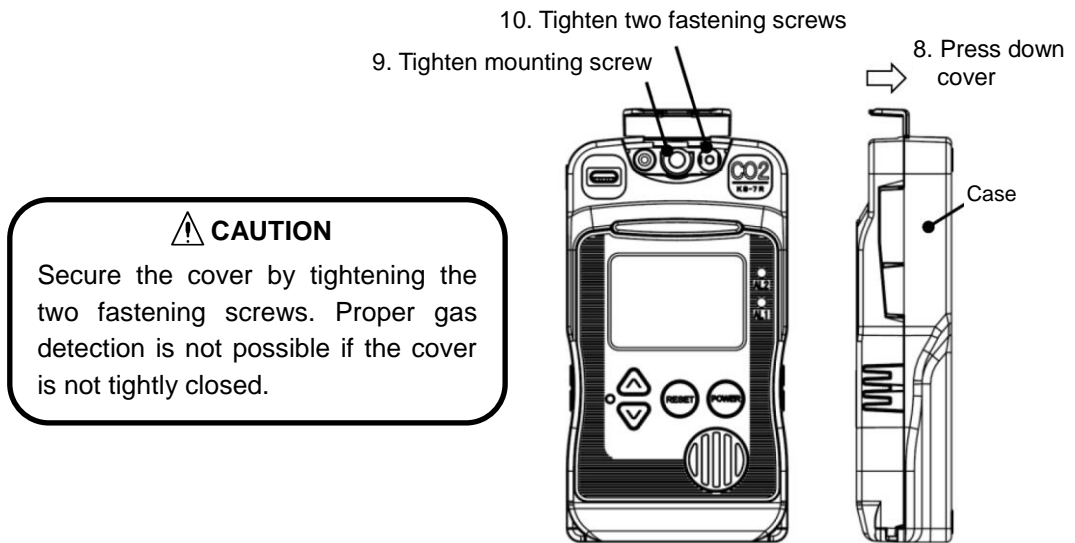

⚠ CAUTION

Secure the cover by tightening the two fastening screws. Proper gas detection is not possible if the cover is not tightly closed.

6. Wiring

WARNING

- Remove any power source during wiring work to prevent electric shocks.
- After wiring is completed, close the detector's cover to prevent electric shocks.

CAUTION

- New Cosmos is not responsible for the cost or any damage resulting from controlling external equipment (e.g. interlock) by using the detector's outputs (e.g. analog output, alarm relay contact output).
- Connect wires to their corresponding terminals by referring to the marking on the terminal block.
- Keep the connection cable away from the electrical power line.
- When using with external devices, isolate the product's 4-20mA analog output from power lines of external devices in order to prevent inflow current and noise.

The knockout holes for cable entry are provided on the back and bottom of the unit, and can be removed using a nipper.

Use a shielded cable (with 0.5 to 1.25mm² wires) up to 500m in length with an outside diameter of 10.5mm or less.

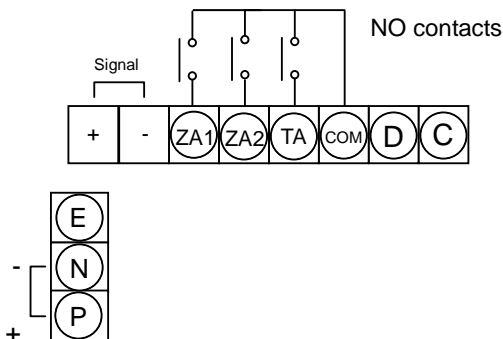
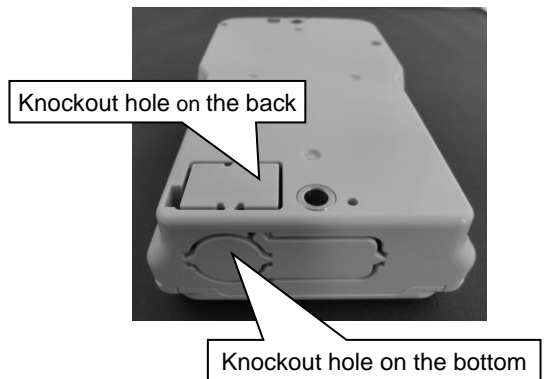

P	+	Power supply, 24 VDC
N	-	
E	Earth terminal for grounding the detector	
Signal	+	Analog output, 4-20mA DC
	-	
ZA1/ ZB1	1 st stage alarm relay contact (Dry NO or NC)	
ZA2/ZB2	2 nd stage alarm relay contact (Dry NO or NC)	
TA/TB	Fault alarm relay contact (Dry NO or NC)	
COM	Common	
D	Not used	
C		

NO: Normally Open

NC: Normally Closed

6-1. Pin Terminal/Insulated Sleeve Installation

Recommended parts/tools

Part	Model (Manufacturer)	Remarks
Electric cable		Shielded cable (with 0.5-1.25mm ² wires) Outer diameter: 10.5mm or less
Pin terminal	TC1.25-16 (Nichifu)	(Included in package) Used for 0.25- 1.65mm ² twisted wire
Insulating sleeve	VC1.25 (Nichifu)	(Included in package)
Crimping tool	NH1 (Nichifu)	1.25

Terminal block (reference)

Part	Model (Manufacturer)	Remarks
Power terminal block	ML-1400-S1L-3P (Sato Parts)	Diameter: 0.65-1.6mm
External output terminal block	FFKDSA1/H1-5, 08-8 (Phoenix Contact)	Diameter: 0.2-1.5mm

1) Wire stripping

Strip the wire.

Recommended stripped wire length: 5.5mm

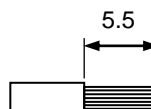

2) Pin terminal installation

Insert the stripped wire into a pin terminal until 1mm of stripped wire can be seen from the end of the pin terminal's barrel.

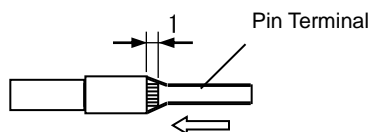

3) Terminal crimping

Crimp the center of the barrel.

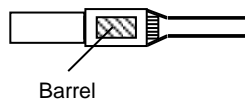

4) Insulating sleeve installation

Attach an Insulating sleeve to the crimped pin terminal.

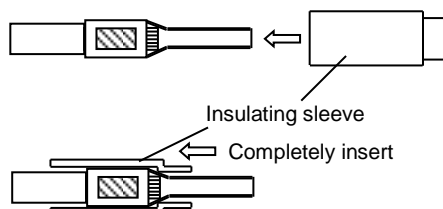

NOTE

Completely insert the pin terminal into the insulating sleeve. Not doing so may cause an insufficient pin length when wired to the terminal block, which may result in a poor connection.

6-2. Wire Connection/Disconnection to/from Terminal Block

6-2-1. Power Terminal Block

(Connection)

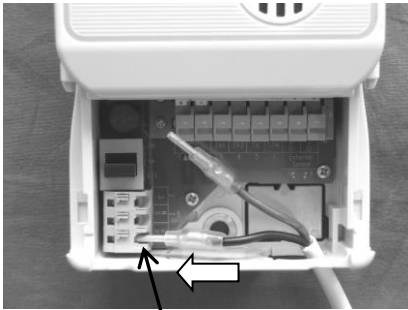

Insert each pin terminal to its corresponding slot on the terminal block.

(Disconnection)

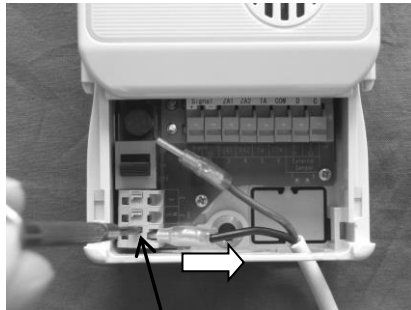

While pressing the release button with a precision screwdriver (recommended tip thickness: 2.6 mm), lift the pin terminal.

6-2-2. External Output Terminal Block

(Connection)

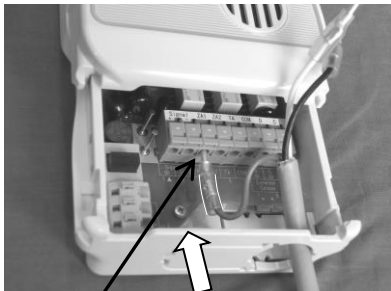

Insert each pin terminal to its corresponding slot on the terminal block.

(Disconnection)

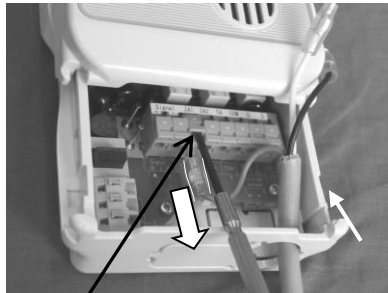

While pressing the release button with a precision screwdriver (recommended tip thickness: 3.0 mm), lift the pin terminal.

6-3. Cable Tie Installation

Use a cable tie for bundling the in-coming cables through the cable entry and secure them to the unit's wall.

The unit has a cable tie holder inside its case near the bottom.

Pre-install a cable tie by feeding it through the tie holder and make a loop. To easily bundle the wiring of in-coming cables to the terminal block, feed these cables through this loop and secure to the case wall.

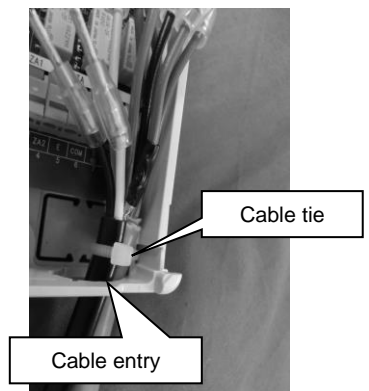

7. Operation

7-1. Precautions before Use

CAUTION

- Before turning on the unit, check that all wiring is correct. Refer to 6. "Wiring" or delivery specifications if provided.
- Ensure there is no target or interfering gas in the air before use.
- Before the sensor output is stable, the relay contacts may possibly activate after the warm-up completes. If the relay contact outputs are used to interlock external devices, release the interlocks to prevent possible activation, if necessary.
- During the warm-up, the analog signal output is fixed at 4mA and the external relay contacts are disabled.

7-2. Operating Procedure

- 1) Follow steps 1, 3, 4, and 5 of 5. "Installation" to slide up and open the cover. (The cover is not fully opened.)
 1. Open the screw cover.
 3. Loosen the two fastening screws.
 4. Slightly pull the cover forward.
 5. Slide the cover up (cover is open).
- 2) Set the main power switch to the on (up) position.
- 3) Follow steps 7, 8, and 10 of 5. "Installation" to close the cover and tighten the screws.
 7. Slide the cover down (cover is closed).
 8. While pressing the cover toward the case,
 10. secure the screw cover to the case with the two fastening screws.

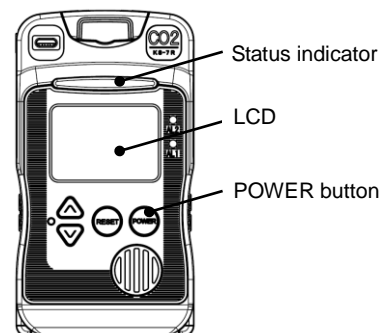
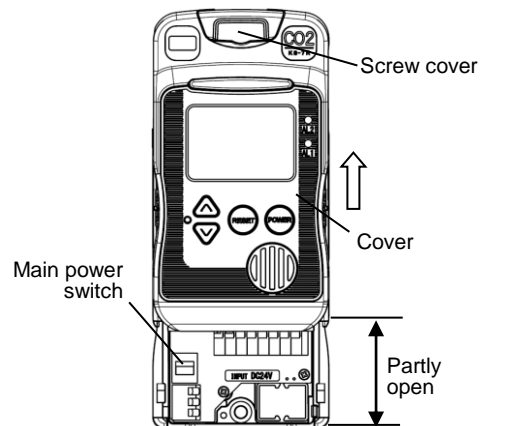

CAUTION

Secure the cover by tightening the two fastening screws. Proper gas detection is not possible if the cover is not tightly closed.

- 4) Press and hold the POWER button for three seconds to turn on the detector. (two beeps) The three green LEDs inside the status indicator start flashing and “- - -” is displayed on the LCD. The warm-up cycle lasts two minutes. During the warm-up cycle, the analog output is fixed at 4 mA, gas and fault alarms are deactivated, and the detector cannot enter to User mode.

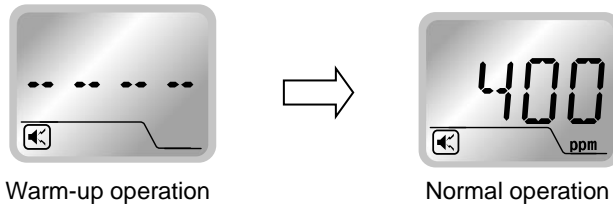

- 5) When the warm-up cycle is completed, the three green flashing LEDs inside the status indicator become solid, the gas concentration is displayed on the LCD, and normal operation starts.
- 6) Perform an alarm test. (Refer to 7-4-5. “Alarm Test”)
Confirm that an alarm activates.
- 7) To turn off the detector, press and hold the POWER button for three seconds to stop its operation, then set the main power switch to the off (down) position.

⚠ CAUTION

If the gas detector has not been powered for a long period of time (i.e. between shipment and initial energization), it may take longer for the sensor to stabilize.

7-3. LCD Operation

7-3-1. LCD

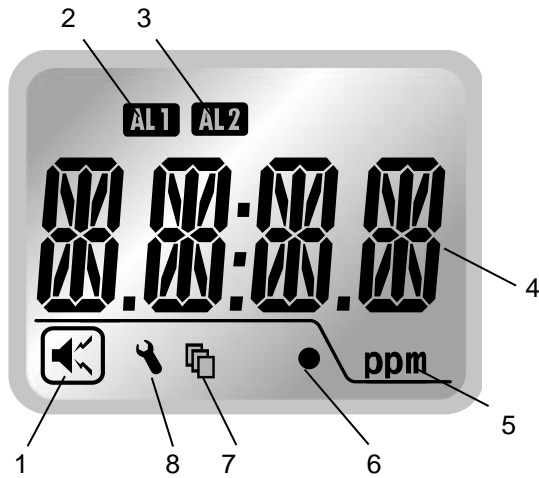





Item	Icon/Display	Description/Function
1	Audio alarm icon	Lit during active audio alarm.
2	AL1 icon	1 st stage alarm notification.
3	AL2 icon	2 nd stage alarm notification.
4	Concentration value and information	CO ₂ concentration value, parameter values, error code, etc.
5	Unit of measurement	A unit of gas concentration.
6	Clock battery level indicator	Lit when the clock battery level is low.
7	Alarm event history icon	Lit when an alarm event is being accessed.
8	Maintenance mode icon	Lit when Maintenance mode is active.

CAUTION

- The LCD indication is fixed at “360 ppm”, even if the actual gas concentration is less.
- The audio alarm icon is not displayed when your detector is a silent alarm option (specified at time of order).

7-3-2. Normal Operation Status

During normal operation the green status indicator is fully lit, the gas concentration value is displayed on the LCD, and the AL1 and AL2 alarm LEDs are off.

Operation buttons	
	POWER button
	RESET button
	▲(UP) button
	▼(DOWN) button
	Maintenance button

7-3-3. Full Scale and Alarm Set Values Display

- Press the RESET button (one beep) to display the “full scale concentration”, “1st stage alarm set value”, and “2nd stage alarm set value” in sequence.



7-3-4. Peak Value Display and Reset

- Press the ▲ button. (one beep) The “peak value after powering-up” and “PEAK” will be displayed alternately.



- To return to the normal gas concentration display, press the RESET button. (one beep)
The display will show the full scale value and alarm set values, then return to the normal gas concentration display.
- To reset the peak value, press the ▲ and ▼ buttons at the same time. (two beeps)
The peak value is reset then the display returns to the normal gas concentration display.

7-3-5. Operation during Gas Alarm

- When the CO₂ concentration reaches the alarm set value, the alarm LED flashes, the status indicator sequentially-flashes and the audio alarm sounds.

NOTE

Audio alarm mute: If the RESET button is pressed during a gas alarm, the audio alarm will be muted and the flashing alarm LED(s) will become solid. If the RESET button is pressed and held, the alarm will not be muted.

- There are two options to clear a gas alarm, manual-resetting and self-resetting. By default, the detector is set to self-resetting mode. Please specify the alarm clearance option at the time of order.
- The alarm hysteresis range is 200 ppm. The alarm will not be cleared until the gas concentration exceeds the alarm set value by more than the hysteresis value. E.g. when the alarm set value is 2000 ppm and an alarm is activated, the alarm will not be cleared until the concentration reaches 1800 ppm or lower.

NOTE

Alarm relay contact reset: If the RESET button is pressed while the concentration is below “alarm set value – hysteresis”, the alarm relay contact will return to its normal position and the alarm LED will turn off.

< 1st stage alarm >

- AL1 alarm LED (amber) flashes and the status indicator sequentially-flashes amber.
- Audio alarm beep: Fast, high and low beep tones.
- COM-ZA1 alarm relay contact closes (when normally open contacts are used). / COM-ZB1 alarm relay contact opens (when normally closed contacts are used).

< 2nd stage alarm >

- AL2 and A1 alarm LEDs (red and amber) flash and the status indicator sequentially-flashes red.
- Audio alarm beep pattern: Very fast high and low beep tones.
- COM-ZA2 alarm relay contact closes and COM-ZA1 alarm relay contact remains closed (when normally open contacts are used). / COM-ZB2 alarm relay contact opens and COM-ZB1 alarm relay contact remains open (when normally closed contacts are used).

7-4. User Mode

NOTE

- During User mode, gas detection, alarm operation, analog output, and contact output activation are active as during normal operation mode. However, audio alarm mute and alarm clearance are not active and cannot be used.
- Return to normal operation mode after using User mode.

7-4-1. User Mode Operation

- To enter User mode, press the maintenance button while the unit is on. After one beep, “1” and its abbreviated mode name “MT” will be alternately displayed.



NOTE

Use a rounded pin (e.g. precision screwdriver) for pressing the Maintenance button.

- To select the mode options, use the ▲ and ▼ buttons.
- To confirm your selection, press the maintenance button. To return to the previous step, press the RESET button.
- To execute the selected mode, press and hold the maintenance button for three seconds.
- To return to normal operation mode, press and hold the RESET button for five seconds.

Mode	Mode name	Abbreviated mode name
1	Switching Maintenance mode on/off	MT
2	Zero adjustment	0 ppm
3	Air adjustment	400 ppm (target concentration level)
4	Alarm test	AL T
5	Alarm event history	AL H
6	Clock setting	DATE

7-4-2. Switching Maintenance Mode On/Off [Mode 1]

WARNING

During Maintenance mode, the gas alarm relay contacts and gas alarm audio are disabled. Turn off Maintenance mode during normal operation.

- 1) Enter User mode. Press the ▲/▼ button to select "1". (each press of the button is followed by one beep) "MT" and "1" (mode number) will be alternately displayed.



- 2) Press the maintenance button. (one beep) "OFF" will flash.



- 3) Press the ▲ button. (one beep) "ON" will flash.



- 4) Press and hold the maintenance button for three seconds (beep pattern: short-long-short-short) to confirm the selection. The maintenance icon is displayed, and "1" and "MT" will be alternately displayed, indicating that the unit is in Maintenance mode.

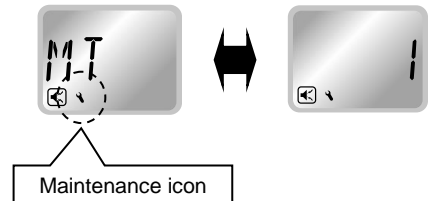

NOTE

If the unit is returned to normal operation mode while in Maintenance mode, the "concentration value" and "- - -" will be alternately displayed and the maintenance icon will remain displayed.



- 5) To end Maintenance mode, take the steps 1) to 4) above to switch Maintenance mode from "ON" to "OFF". Confirm the maintenance icon has turned off.



7-4-3. Zero Adjustment [Mode 2]

CAUTION

- Do not perform a zero adjustment. Accurate detection is not possible without proper adjustment.
- To adjust the sensor, a zero or air adjustment is necessary. Air adjustment is recommended.
- Sensor adjustment (air/zero adjustment) should only be performed by qualified technician. For adjustment, contact your New Cosmos representative (fees apply).

Enter User mode. Press the ▲/▼ button to select “2”.
(each press of the button is followed by one beep)
“0 ppm” and “2” will be alternately displayed.



7-4-4. Air Adjustment [Mode 3]

CAUTION

- Do not perform an air adjustment. Accurate detection is not possible without proper adjustment.
- To adjust the sensor, a zero or air adjustment is necessary. Air adjustment is recommended.
- Sensor adjustment (air/zero adjustment) should only be performed by qualified technician. For adjustment, contact your New Cosmos representative (fees apply).
- 400 ppm CO₂ gas is used for air adjustment.

Enter User mode. Press the ▲/▼ button to select “3”.
(each press of the button is followed by one beep)
“*** ppm” (target concentration level) and “3” will be alternately displayed.

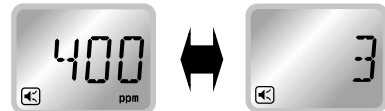

(E.g. Target concentration level is 400 ppm)

7-4-5. Alarm Test [Mode 4]

When an alarm test is executed, the alarm test value (concentration) will be displayed on the LCD, and corresponding analog output and alarm outputs (gas alarm relay contacts, audio alarm, alarm LEDs) will activate. This will allow the user to test the alarm operation.

NOTE

- If the unit is in Maintenance mode, the gas alarm relay contacts and gas alarm audio are disabled (alarm LEDs and analog outputs are active).
- The possible test value range is from 0 to 5000 ppm.

CAUTION

- An alarm test activates the alarm relay contacts of the detector. If the alarm relay contact outputs are used to interlock external devices, release the interlocks before the alarm test, if necessary. Notify those concerned before starting gas detection system inspection.
- Observe the applicable laws and regulations.

- 1) Enter User mode. Press the ▲/▼ button to select “4”. (each press of the button is followed by one beep) “AL T” and “4” will be alternately displayed.
- 2) Press the maintenance button. (one beep). The current alarm test value (ppm) will be displayed.
- 3) To change the alarm test value (ppm), press the ▲/▼ button.

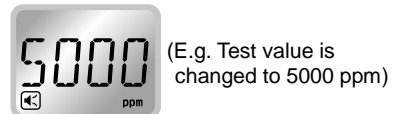
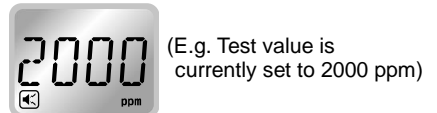

NOTE

To increase/decrease the test value, press the ▲/▼ button. Holding the button continuously increases/decreases the value.

- 4) Press and hold the maintenance button for three seconds to start an alarm test. (two beeps)
- 5) To cancel the ongoing alarm test, press the RESET button. (one beep) The current alarm test value (ppm) will be displayed. (Note: If the RESET button is pressed and held, the alarm will not be cancelled and the unit will return to normal operation mode.)
- 6) To change the test value, repeat steps 3) to 5).
- 7) Press and hold the RESET button for five seconds to return to normal operation mode.



7-4-6. Alarm Event History [Mode 5]

Up to the 10 most recent alarm events can be displayed (automatically updated).

For each alarm event, the following sequence of information is displayed: peak value (ppm) during the alarm, starting and ending times (year/month/day/time) of the alarm.

Press the RESET button to return to the previous screen.

- 1) Enter User mode. Press the ▲/▼ button to select “5”.
(each press of the button is followed by one beep)
“AL H” and “5” will be alternately displayed.

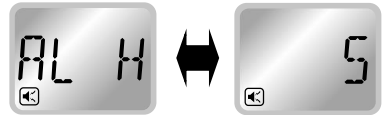

- 2) Press the maintenance button (one beep) The most recent alarm event number “H1” will be displayed. If there is no alarm event, “INIT” will be displayed.

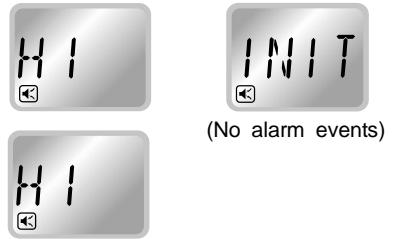

- 3) Use the ▲ button (each press of the button is followed by one beep) to select (display) the desired alarm event from H1 to H10.

NOTE

Each press of the ▲ button cycles through alarm events. The sequence is H1, H2, to H10, and INIT. To delete all the alarm events, select “INIT”, then press and hold the maintenance button for three seconds. (beep pattern: short-long-short-short) It is not possible to delete single alarm events.

- 4) Press the maintenance button. (one beep)
The alarm event history icon is present, and the display alternates between “AL” and the “peak value” (ppm) for the selected event.

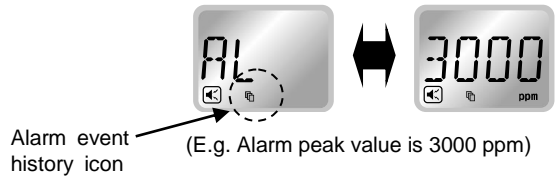

- 5) Each press of the ▼ button cycles through the details of the selected alarm event. The sequence is: starting year, date, and time and ending year, date, and time of the event.



- 6) Press the RESET button (one beep) to display the selected alarm event number "H *".
To display other alarm events, repeat steps 3) to 5).



(E.g. H1 is selected)

To delete all the alarm events, select "INIT" in step 3), then press and hold the maintenance button for three seconds. (beep pattern: short-long-short-short).
All alarm events are now deleted.

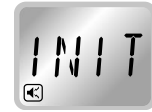

7-4-7. Clock Setting [Mode 6]

Clock is used when recording alarm events.

- 1) Enter User mode. Press the ▲/▼ button to select "6". (each press of the button is followed by one beep) "DATE" and "6" will be alternately displayed.
- 2) Press the maintenance button. (one beep) "YEAR" and "**** (year)" will be alternately displayed.
- 3) Select the item to change with the ▲ button. The item and its currently set value will be displayed.

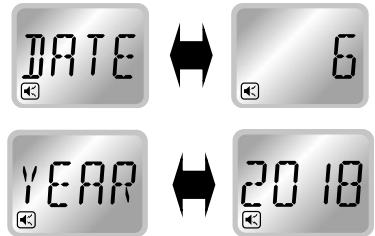

NOTE Each press of the ▲ button cycles through: "YEAR", "MON" (month), "DAY", "HOURL" and "MIN" (minute).

When selecting "YEAR", for example,

- 4) Press the maintenance button. (one beep) The currently set year will be displayed.
- 5) Change the set value by using the ▲/▼ button.
- 6) Press and hold the maintenance button for three seconds to confirm the change. (beep pattern: short-long-short-short) "YEAR" and the set year will be alternately displayed.
- 7) To change the other items, repeat steps 3) to 6).
- 8) Press and hold the RESET button for five seconds (two beeps) to return to normal operation mode.

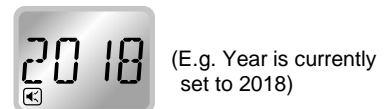

(E.g. Year is currently set to 2018)

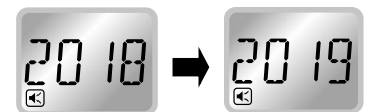

(E.g. Changed from 2018 to 2019)



(confirmed)



(Back to normal operation mode)

7-5. Maker Mode

All the items set in Maker mode (e.g., alarm set value) are password-protected.

WARNING

- Incorrect settings in Maker mode may change the detector's specifications. Never operate in a way other than as described in this instruction manual.
- Only a selected administrator should make changes in Maker mode.
- Gas detection is not possible while in Maker mode. To exit and return to normal operation, power cycle the unit before use.

7-5-1. Maker Mode Activation

There are two methods to enter Maker mode.

1. Turn off the detector. Then simultaneously press and hold the ▲ and ▼ and POWER buttons for three seconds (two beeps) to activate Maker mode.
2. Press and hold the maintenance button while in normal operation mode.

The software version is displayed, followed by all the LCD segments displayed, and finally "775" starts flashing. Now Maker mode is active.

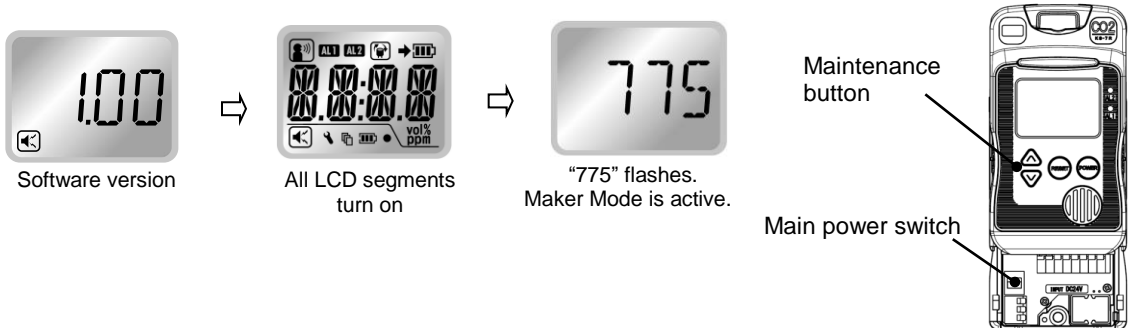

CAUTION

Only enter 775 to enter Maker mode.

7-5-2. Alarm Set Value Change

- 1) Refer to 7-5. "Maker Mode".
Enter Maker mode. "775" flashes.
- 2) Press the maintenance button. (one beep)
"AL 1" will be displayed and the AL1 icon will turn on.



- 3) Use the ▲ button (one beep) to select the alarm stage, AL1 or AL2.

NOTE Each press of the ▲ button alternates between "AL1" and "AL2".



- 4) Press the maintenance button to confirm the selection. (one beep) The current alarm set value for the selected alarm stage will be displayed.



- 5) Change the alarm set value by using the ▲/▼ button.



(E.g. Changed to 25ppm)

- 6) Press and hold the maintenance button for at least three seconds to confirm the change. (beep pattern: short-long-short-short)
"AL1" or "AL2" will be displayed.

NOTE If the alarm set value change is not successful, the unit will beep two times and the previous set value remains displayed. In this case, press and hold the POWER button for three seconds to turn off the unit, then repeat the procedure. If the unit still fails to change the alarm set value, contact your New Cosmos representative for repair.



- 7) To change another alarm set value, repeat steps 3) to 6).
- 8) To end the procedure, press and hold the POWER button for three seconds to turn off the unit.
- 9) Press and hold the POWER button for three seconds to restart the unit in normal operation mode. Check the alarm set values. (Refer to 7-3-3. "Full Scale and Alarm Set Value Display".)

8. Maintenance

Daily checks are carried out by the user, while monthly and annual inspections are performed by the user, New Cosmos or its authorized representative.

Important Notice for Maintenance

In order to ensure the reliability of the gas detector, it is vital to perform periodic air adjustment on the gas sensor. It is highly recommended that a maintenance contract with a local New Cosmos representative be made for the performance of scheduled adjustment and replacement.

8-1. Inspection Contents and Frequency

Check items	Start-up	Expansion or relocation	Periodic Inspection		Daily check
			Monthly	Annually	
1) Concentration display	√	√			√
2) Alarm test	√	√	√		
3) Air adjustment (gas calibration)				√*	
4) Sensor replacement				√* Every 5 years	

* Contact your New Cosmos representative for air adjustment/sensor replacement (fees apply).

- 1) Concentration Display
Check that the CO₂ concentration is displayed on the LCD and that the detector operates properly.
- 2) Alarm Test
Check that an alarm activates correctly by conducting an alarm test. Refer to 7-4-5. "Alarm Test".

CAUTION

- Perform an alarm test in accordance with the applicable local laws and regulations. For example, an applicable law in Japan specifies that alarm activation must be checked by performing a circuit check once every month.
- An alarm test activates the alarm relay contacts of the detector. If the alarm relay contact outputs are used to interlock external devices, release the interlocks before the alarm test, as necessary.

Notify those concerned before starting gas detection system inspection.

3) Air Adjustment (Gas Calibration)

To ensure reliable gas sensor performance, perform an air adjustment at least once a year.

 **CAUTION**

- Air adjustment should be performed by qualified technician only. For air adjustment, contact your New Cosmos representative (fees apply). Accurate gas detection is not possible without a proper air adjustment.
- 400 ppm CO₂ gas is used for air adjustment.

4) Sensor Replacement

It is highly recommended to replace the sensor every 5 years when used in a normal environment. However, if any abnormality, e.g., a significant decrease in sensor sensitivity, is found during a periodic inspection or daily check, the sensor needs to be replaced. Contact your New Cosmos representative for sensor replacement.

NOTE

Even if the detector is unused for a long period of time, replace the sensor 5 years from the purchase date. Contact your New Cosmos representative for sensor replacement (fees apply).

8-2. Clock Battery Replacement

CAUTION Use a “CR2032 lithium battery, coin type” for clock battery.

1. Press and hold the POWER button for three seconds to turn off the detector.
2. Open the screw cover.
3. Loosen the two fastening screws (these screws cannot be fully removed).
4. Slightly pull the cover forward.

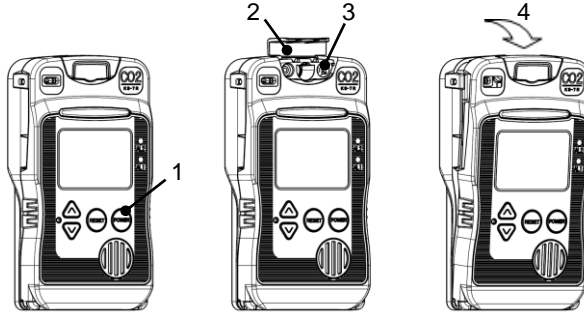

5. Slide the cover up by holding it by the sides until the alignment markings on cover and case match.
6. Set the main power switch to the off (down) position to turn off the main power.

CAUTION

Turn off the detector's main power to avoid electric shocks.

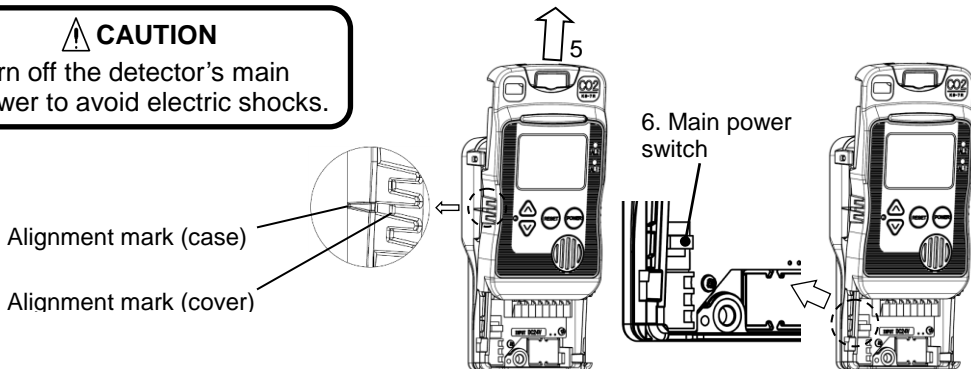

7. Pull and detach the cover from the case.

CAUTION Cover and case are connected with connector cable.

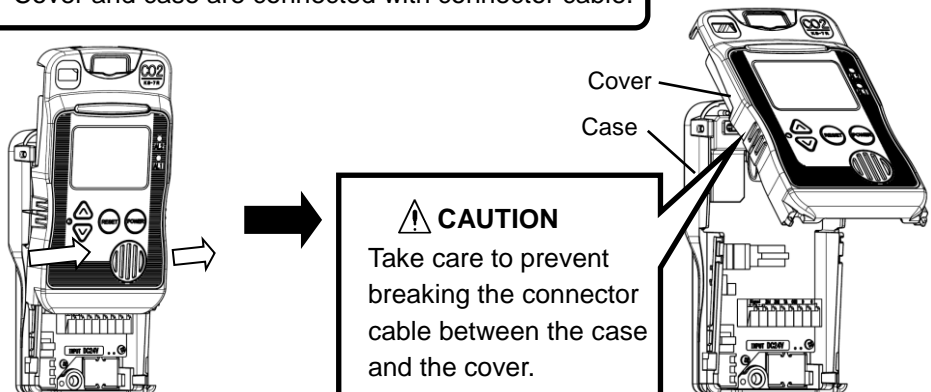

9. Troubleshooting

Before requesting repair, please refer to the table below. If the detector does not return to normal operation after performing the corresponding steps in the table, or if your issue is not found in the table, consult New Cosmos or its authorized representative.

Problem	Probable cause	Solution	Reference section
Green status indicator not lit.	Main power switch or POWER button is off	Set the main power switch to on position or press and hold the POWER button for three seconds.	7-2. Operating Procedure
	Incorrect wiring or loose connection	Check and rewire/reconnect.	6. Wiring
	No power supplied	Supply correct power.	7-1. Precautions before Use
Maintenance icon displayed on LCD, and gas concentration value and “_ _ _ _” displayed alternately.	Product is in Maintenance mode	Switch Maintenance mode to OFF.	7-4-2. Switching Maintenance Mode On/Off
No audio alarm.	Product is in Maintenance mode	Switch Maintenance mode to OFF.	7-4-2. Switching Maintenance Mode On/Off
	Incorrect alarm set value	Check the alarm set value.	7-3-3. Full Scale and Alarm Set Value Display
	Silent alarm option selected at time of order	Consult your New Cosmos representative.	
Alarm relay contacts do not activate.	Product is in Maintenance mode	Switch Maintenance mode to OFF.	7-4-2. Switching Maintenance Mode On/Off
	Incorrect wiring or loose connection	Check and rewire/reconnect.	6. Wiring
	Incorrect alarm set value	Check the alarm set value.	7-3-3. Full Scale and Alarm Set Value Display

Problem		Probable cause	Solution	Reference section
<ul style="list-style-type: none"> ▪ Status indicator flashing between green and red. ▪ Audio alarm sounds. ▪ Fault alarm relay contact activates. ▪ Analog output is lower than 0.9mA. 	"E-E1", "E-E2", or "E-E3" displayed on LCD.	Device failure	Press and hold the POWER button for three seconds to turn off the detector. After a few minutes, turn the detector on again. If the unit does not return to normal operation, contact your New Cosmos representative for repair.	7-2. Operating Procedure
	"E-S1", "E-S2", or "E-S3" displayed on LCD.	Sensor failure		
Other than the above		Microcomputer malfunction due to noise.	Turn off and on the detector. If the unit does not return to normal operation, contact your New Cosmos representative for repair.	7-2. Operating Procedure

10. Specifications

Detection principle	NDIR
Sampling method	Diffusion type
Target gas	Carbon Dioxide
Detection range *1	360 to 5000 ppm
Display	Four-digit LCD with backlight, 5 ppm resolution
Alarm set value	AL1: 2000 ppm, AL2: 5000 ppm
Detection accuracy	0 to 40°C: ± 5% of F.S. Others: ± 10% of F.S.
Response time *2	T90: 90 sec., T60: 60 sec., T50: 50 sec.
Alarm	<ul style="list-style-type: none"> ▪ Gas alarm (in two stages) 1st stage alarm: AL1 alarm LED flashes (lit if the audio alarm is muted), amber status indicator sequentially-flashes, audio alarm sounds, and AL1 icon is displayed on LCD. 2nd stage alarm: AL1 and AL2 alarm LEDs flash (lit if the audio alarm is muted), red status indicator sequentially-flashes, audio alarm sounds, and AL1 and AL2 icons are displayed on LCD. ▪ Alarm clearance method: selectable to self-resetting (default) or manual-resetting at the time of order.
External output	<ul style="list-style-type: none"> ▪ Gas concentration analog output 4-20 mADC (common negative with power supply) <ul style="list-style-type: none"> - Normal operation: 5.15 to 21.6 mA (360 to 5500 ppm) - Warm-up: 4 mA - Fault status: 0.9 mA or below Current sensing resistor must be 300Ω or less including a wiring resistance. ▪ Gas alarm relay contacts (in two stages) Dry normally open (default) or close contacts, latching type Selectable to self-resetting (default) or manual-resetting at the time of order (Max load: 2 A at 30 VDC (resistance load)) ▪ Fault alarm relay contact Dry normally open (default) or normally close contacts, latching type (Max load: 2 A at 30 VDC (resistance load))
Explosion-proof	Not explosion-proof
Compliance *3	EMC:2014/30/EU/SI 2016 No.1091 RoHS:2011/65/EU+(EU)2015/863/SI 2012 No.3032
Other features	<ul style="list-style-type: none"> ▪ Maintenance mode used to disable gas alarm relay contacts and gas alarm audio. ▪ Audio alarm mute
Applicable cable	0.5 to 1.25mm ² shielded cable. Outer diameter: less than 10.5mm
Cable length	Up to 500m
Operating temperature and humidity	-10 to +50°C, 0 to 85%RH (No rapid temperature/humidity changes. No condensation)
Power supply	24 VDC ± 10%
Power consumption	1 W during normal operation, 3 W during alarm
Dimensions	W82 x H150 x D35 mm
Mass	Approx. 300g
Mounting method	Wall mounting, indoors

*1: Do not use the product in an area where the CO₂ concentration is less than 360 ppm.

*2: Measured under identical environment at 20°C, 50%RH and 1,013hPa.

*3: CE marking specification applies to KS-7R which uses 24 VDC power. Refer to the “EU Declaration of Conformity” (separate document) for information on the CE marking unit.

11. Warranty

The warranty period is one (1) year from the date of purchase.

You are entitled to the limited warranty, if the product malfunctions due to a manufacturing defect during normal use in accordance with the instruction manual, specifications and labels.

Warranty Scope

If the product fails or is found to be damaged due to a manufacturing defect during the warranty period, and used in accordance with the instruction manual and specifications, we will provide a free replacement or repair service. This warranty covers the New Cosmos product/parts only and not third-party product/parts.

Warranty Exclusions

The following will be repaired at the cost of customer even during the warranty period.

- (1) Failures and damages incurred by incorrect use, deliberate acts or negligence of the user.
- (2) Failures and damages caused by disaster, earthquake, storm and flood, lightning, extreme climate, abnormal power supply voltage, excessive electromagnetic interferences, or other acts of God.
- (3) Failures and damages resulting from repair and/or modification by non-New Cosmos certified technicians.
- (4) Consumables and failures and damages resulting from improper consumable replacement.
- (5) Other failures and damages not attributable to the manufacturer.

12. Expected Sensor Life

The estimated service life of the sensor is shown in the table below. The sensor may fail to provide correct detection after its service life expires. Replace the sensor before its expiration. This expected service life assumes that maintenance is done properly and periodically and that the sensor is not exposed to high concentration gas or gas that may cause sensor poisoning. This does not imply that the sensor will provide correct detection values up to the end of the service life. Thus, no warranty will be given after the one-year period is over.

Detection principle	Expected sensor life
Non-dispersive infrared (NDIR) sensor	5 years

13. Detection Principle

Non-dispersive infrared sensor (NDIR)

Gas is molecules made of different chemical atoms. Each gas has a strong absorbance of infrared light at specific wavelengths in the 1 to 20 μ m Infrared spectrum, and the amount of absorbed infrared light is proportional to its gas concentration according to the Beer-Lambert law. By using this characteristic, it is possible to measure the gas concentration of a target gas based on the amount of infrared light absorbed. Furthermore, the gas selectivity of the sensor can be enhanced by the addition of an optical filter, which filters out all light outside of the wavelength that target gas molecules can absorb.

Typical model of NDIR is shown below.

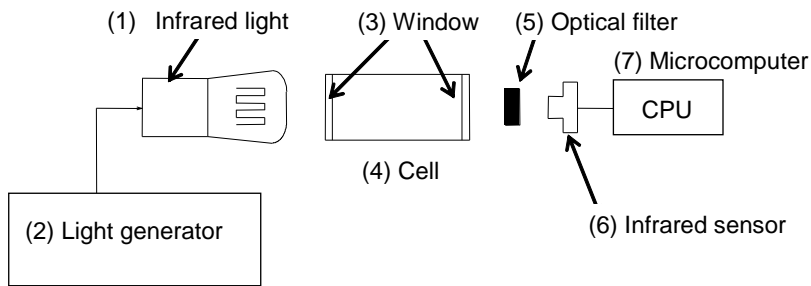

The infrared radiation from the infrared light source (1) is chopped by the light regulator (2). The infrared light passes through the windows (3) and cell (4) to the optical filter (5), which allows only certain wavelengths to pass to the infrared sensor (6), which then measures the amount of infrared absorbed by the gas. The absorbed amount is converted to an electric signal, which is converted to a gas concentration by the microcomputer (7).

14. Glossary

Term	Definition
Clean air or normal air	Standard atmosphere which contains 20.9 to 21.0% oxygen in dry condition or atmosphere without target gas or interference gases.
Gas detector	Device used to detect the presence of a target gas and to give its concentration in the form of an electrical signal.
Diffusion type	Sampling method using convective diffusion while placing a gas detector at a detection point.
Target gas	Specific gas to be detected, concentration displayed, and used to trigger alarms.
Detection range	A range of target gas concentrations that can be displayed and trigger alarms.
Alarm set value	Preset gas concentration level at which an alarm is triggered.
Operating temperature and humidity ranges	Ambient temperature and humidity ranges in which the gas detection and alarm system can operate normally.
Maintenance and inspection	Tasks performed to ensure that equipment operates normally and correctly.
Self-resetting (or Auto-resetting)	Gas alarm clearance method. When the gas concentration falls below (or above when the alarm set value is the lower limit) the gas alarm set value after an alarm has been signaled, relevant alarm lights, gas alarm icon and alarm relay contacts will automatically return to their normal positions/statuses.
Manual-resetting	Gas alarm clearance method. Even if the gas concentration falls below (or above when the alarm set value is the lower limit) the gas alarm set value after an alarm has been signaled, relevant alarm lights, gas alarm icon, and alarm relay contacts will not automatically return to their normal positions/statuses. Manual operation is only possible when the gas concentration is below (or above) the gas alarm set value.
Hazardous area	An area in which an explosive atmosphere is present, or may be expected to be present, in quantities such as to require special precautions for the construction, installation and use of electrical apparatus.
Explosive atmosphere	Mixture of air and flammable substances in the form of dust or vapor which are within their explosive limits.
Sequentially-flash	There are several LEDs inside the status indicator. In the event of a gas alarm, one LED lights at a time and the lit LED moves from left to right.

15. Proper Product Disposal at End of Life



The Waste Electrical and Electronic Equipment (WEEE) directive (2012/19/EU) is intended to promote recycling of electrical and electronic equipment and their components at end of life. This symbol (crossed-out wheeled bin) indicates separate collection of waste electrical and electronic equipment in the EU countries. This product contains two Lithium batteries. Specific battery information is given in this instruction manual. Batteries must be recycled or disposed of properly. At the end of its life, this product must undergo separate collection and recycling from general or household waste. Please use the return and collection system available in your country for the disposal of this product.

(Blank page)

Revision History

Document No.	Date	Revision
GAE-139-00	Feb 2019	0 (Initial issue)
GAE-139-01	June 2019	1
GAE-139-02	February 2021	2
GAE-139-03	September 2022	3

Additional copies of this instruction manual may be purchased.
Contact New Cosmos or its authorized representative for ordering.

Authorized representative:

Manufacturer:

NEW COSMOS ELECTRIC CO., LTD.

2-5-4 Mitsuya-naka, Yodogawa-ku,
Osaka 532-0036, Japan

www.newcosmos-global.com

NEW COSMOS ELECTRIC CO., LTD.